

Jonsered 1188S CE

Operator's Manual GB

This operator's manual is an Original Instruction and applies for cranes from serial number:
BJ1188S00000

2019-05

Congratulations with your new crane!

You are now the owner of a quality product from Cargotec, built to the highest standards of safety and quality.

The aim of this manual is to help you handle your crane safely and with full satisfaction.

Please read the complete manual. It provides detailed information about the crane, control system and the practical management and maintenance of the crane.

We advise you to read it carefully and familiarize yourself with your crane before you start to use it.



Help us to improve this manual. Please send your comments and suggestions to **documentation@hiab.com**

Table of Contents

1. Introduction	7
1.1. This Operator's Manual is intended for operators of this crane.	7
1.1.1. Cleanliness certificate	8
1.1.2. The Machinery Directive 2006/42/EC	9
1.1.3. Description of Jonsered 1188S	9
1.2. Indications in the Operator's Manual	9
1.3. Identification of this crane	12
2. Structure and parts of the crane	13
2.1. Main groups	13
2.2. Crane base with column and slewing system	13
2.3. Boom system and add-on lifting accessories	14
2.4. Stabiliser system	14
2.5. Operating system - hydraulic components	14
2.6. Buttons on the control panel [option]	15
2.7. Premium high seat [option]	15
2.8. Cabin [option]	16
2.8.1. Control panel in the cabin C912	16
2.8.2. Control panel in the Hi-Cab	17
2.8.3. Fuses in the cabin Hi-Cab	18
2.8.4. Fuses in the cabin C912	18
2.9. Main control valve	19
2.10. Stabiliser control valve	19
3. Safety precautions and warnings	21
3.1. Operating conditions	21
3.2. Wind speeds	22
3.3. Noise declaration	22
3.4. Signs on the crane	23
3.5. Maximum load	23
3.6. Signals when using a crane	24
3.7. Use of the crane	28
3.7.1. Use of lifting equipment	34
3.7.2. Use of dismantable cranes	35
4. The CE system [option]	37
4.1. How the CE system works	37
4.2. Components in the CE System	37
4.3. Buttons and indicating lights on the interface	38
5. Manual control system [option]	40
5.1. Operation from the high seat	40
5.2. Manual operation from cabin	41
6. HPC [option]	42
7. The control system TimberTronics [option]	43
7.1. The TimberTronics control system	43
7.2. Components in the TimberTronics system	43
7.3. Display	44
8. The control system Multidrive2 [option]	51
8.1. The control system Multidrive2	51
8.2. Components in the Multidrive2 System	51

8.3. Multidrive2 control levers and display	51
8.4. Buttons and indicator lights on the PDF	54
9. Starting crane operation	56
9.1. Starting operations	56
9.2. Attach the crane to the vehicle	56
9.3. Electric tiltable seat [option]	57
9.4. Extend stabiliser extensions and set stabiliser legs	58
9.4.1. Stabiliser system and ground conditions	59
10. During operation	61
10.1. Operate the crane	61
10.2. Slope control [option]	62
10.3. Adjust the speed of each function for TimberTronic control system	62
11. Ending crane operation	63
11.1. Placing the stabiliser system in transport position	63
11.2. Electric tiltable seat [option]	64
11.3. Ending use	65
11.3.1. For cabins [Option]	66
11.4. Warning interface (TWI)	67
11.5. Remove the crane from the vehicle (console mounted)	67
11.6. Emergency operation of the dump valve	68
12. Maintenance and Service	69
12.1. Warranty	69
12.2. Service	69
12.3. Follow the maintenance instructions!	70
12.3.1. Daily inspection	71
12.3.2. Additional daily inspection for the cabin (if installed)	72
12.3.3. Weekly inspection and maintenance	72
12.3.4. Additional weekly inspection and maintenance for the cabin (if installed)	73
12.3.5. Monthly inspection and maintenance	73
12.3.6. Additional monthly inspection and maintenance for the cabin (if installed)	74
12.3.7. Twice a year maintenance	75
12.3.8. Annual maintenance	75
12.3.9. Additional annual maintenance for the cabin (if installed)	76
12.4. Lubrication	76
12.4.1. Lubrication	77
12.4.2. Lubrication of the upper column bearing	77
12.4.3. Lubrication of ball joints in cabin	78
12.4.4. Clean and grease the spring cups.	78
12.5. Adjust the lateral clearance of the boom and/or hydraulic extension	79
12.6. Adjust the chain in the telescope	79
12.7. Cabin [option]	80
12.7.1. Adjust the slide pads in the cabin	80
12.7.2. Tightening of screws and bolts in cabin	80
12.7.3. Windshield wiper fluid	81
12.7.4. Change wiper blade	81
12.7.5. Replace leds on the control panel	82
12.7.6. Change the air filter	82
12.8. Hydraulics	83

12.8.1. Crane base: checking the oil level/oil change	83
12.8.2. Bleeding air from the hydraulic system	83
12.8.3. Replacing the cartridge in return oil filter	84
12.8.4. Replacing the cartridge in high pressure filter	85
12.8.5. Checking the oil tank level	86
12.8.6. Changing the hydraulic oil	86
12.9. Troubleshooting	88
12.9.1. Faults in the crane	88
12.9.2. Faults on the CE device	89
13. Diesel heater [Option]	91
13.1. Diesel heater [option]	91
14. Technical Data	94
14.1. Load plate table	94
15. Decommissioning	95
15.1. Decommissioning a crane	95

This page is intentionally left blank.

1. Introduction

1.1. This Operator's Manual is intended for operators of this crane.

This manual describes:

- Operation
- Safety precautions and warnings
- The crane control system
- Maintenance and troubleshooting

Enclosed to this manual the Installer will provide:

- Technical Data for your crane
- Technical Data and manuals for add on equipment if fitted

Therefore you should:

- Study the entire Operator's Manual carefully.
- Study the operating manuals for other add-on equipment, if fitted.
- Use the crane only after having done so.
- Follow the directions for use, operation and maintenance of the crane and add on equipment exactly.
- Store the Technical Data and manuals from the Installer, together with this Operator's manual.

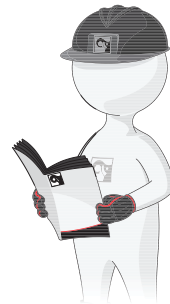

NOTE

The manufacturer reserves the right to change specifications, equipment, operating instructions and maintenance instructions without prior notice.

Study these instructions carefully



DANGER

If you do not study the complete Operator's Manual for your crane carefully, it could lead to fatal accidents or serious damage.

1.1.1. Cleanliness certificate

All Hiab equipment has been tested and certified at the factory according to the Hiab Standard C250.52 that defines the Cleanliness Requirements for Hydraulic Systems. This means that they fulfil the cleanliness class **20/18/14** measured by the ISO 4406 standard.

All hydraulic functions have been individually tested and fully comply with the defined requirements.



NOTE

Hiab shall at all times have the right to:

- install, maintain and dismantle remote diagnostics tools or similar sensor-based connectivity capabilities ("Connectivity") in and from the Equipment; and
- access, send, receive, collect, store and use any and all information and data gathered through the Connectivity, including but not limited to, information concerning efficiency, availability, downtime, operation, operating environment, movement, condition, logon, location and similar information relating to the Equipment (the "Information"). Such Information may be used for optimizing the Equipment, or any related equipment or services as well as for Hiab's internal business and/or operating purposes. Hiab shall be responsible for complying with applicable laws and regulations related to such Information.

The customer/user shall not in any way remove, disable, or interfere with the Connectivity or the Information. Any intellectual property rights or other right and title in and to the Connectivity features and the Information and all their further developments shall at all times be and remain the exclusive property of Hiab.

1.1.2. The Machinery Directive 2006/42/EC

- Business name and full address where the crane is manufactured (2):
Factory addresses:
Cargotec Sweden AB Hiab SE-824 83 Hudiksvall Sweden
Cargotec Poland Sp. z o. o. Ul. Metalowa 2, 73-110 Stargard Szczecinski, Poland
- The Declaration of Conformity, delivered with the crane contains (1):
- Description and identification of the timber handling crane (3):
Mark
Type: see chapter Identification of the timber handling crane.
Serial number
Manufact. year
Declaration of which provisions the timber handling crane fulfils.
- Name and address of the person authorised to compile the technical file (4):
Name
Address
- Identity and signature of the person who drawn up the declaration (5):
Name
Position
Date and Signature

Declaration of conformity with the Machinery Directive 2006/42/EC

We ①
.....

hereby declares that the timber handling crane:

Mark:
Type: ②
Serial number:
Manufact. year:

- complies with the provisions of the machinery directive 2006/42/EC;
- also complies with the provisions of the directive on electromagnetic compatibility 2004/108/EC as amended; ③
- complies with the harmonised standard EN 12999:2011/A1:2012.

Technical file in accordance with Directive 2006/42/EC, Annex VII A is compiled by: ④

Name:

Address:

This declaration is drawn up by:

Name: ⑤

Position:
XXXXXXX

.....

1.1.3. Description of Jonsered 1188S

The Jonsered 1188S is designed for loading cut-to-length timber with a grapple, Usually installed on a timber truck, either in the rear or behind the cab, it is not intended for hook duty .

The Jonsered 1188S is available in many versions with a wide range of accessories, and fulfills the requirements of the European Machinery Directive as specified by the standard EN12999.

On the serial number plate, you can find information on the crane type and on the manufacturer.



NOTE

The exact technical information for your crane is shown in "Technical Data".

1.2. Indications in the Operator's Manual

What must you do and not do?

The following indications are used in the Operator's Manual:

**DANGER**

Danger to life for yourself or to bystanders.

Follow the instructions carefully!

**WARNING**

Danger of injury to yourself or to bystanders, or danger of serious damage to the crane or other objects.

Follow the instructions carefully.

**CAUTION**

Hazard for the crane or crane components. Follow the instructions carefully.

Important:

If actions are numbered

1. Do this
2. Do that
3.
4.
5.

you should carry them out in numerical order!

**NOTE**

Extra information that can prevent problems.

**TIP**

Tip to make the work easier to carry out.

Symbol for reference to a component in an illustration.

(1) Refers to a component in an illustration.

[option]: Indication for parts that are not-standard for the crane, but are an option. Not all [option] are available for your crane.

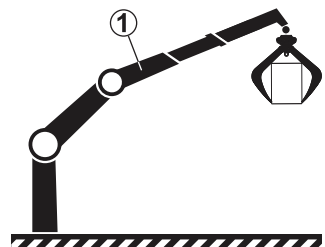



DANGER

Only persons with the requisite knowledge and experience with cranes may use the crane. Never operate the crane when you are sick, tired, under the influence of medicines, alcohol or other drugs.

- Take the delivery instructions from your Hiab Service workshop, or receive instruction from an experienced person from your own company. Only then should you operate your crane.
- Ensure that you comply with the statutory requirements of the country in which you use the crane (for example, certificate, obligatory safety-helmet).



DANGER

- Carry out yourself only the service and maintenance work you have the requisite knowledge and experience of.
- All other maintenance work may only be carried out by a Hiab service workshop.
- Ensure that every defect is rectified immediately, according to the instructions.
- Follow the instructions exactly!
- All other work to rectify faults must be performed by personnel in a Hiab service workshop!

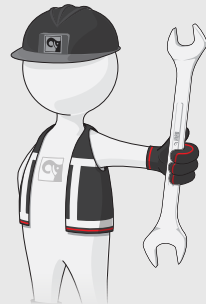

WARNING

- Never clean the electronic system, plastic components, signs or bearings with a high-pressure jet cleaner. It could cause damage.
- Never expose the electronic system to high electrical voltages. This could damage the control system.
- Never immerse the controller in water or other liquid. This will make the controller unusable.

If your crane is equipped with add-on lifting equipment (hoist, rotator, etc.):

- The operation of the crane with add-on lifting equipment can differ from the operation as described in this manual.
- You should therefore study the Operating Manual for the add-on equipment carefully, before you use the crane.
- Take particular note when placing the crane in to or out of transport position.

1.3. Identification of this crane

Description and identification of the crane:

Mark:

Type:

Serial number:

Manufact. year:

Mark:
Type:
Serial number:
Manufact. year:

2. Structure and parts of the crane

2.1. Main groups

The crane consists of the following main groups:

- (1) Crane base with column and slewing system
- (2) Boom system
- (3) Operating system (depends on the configuration)
- (4) Stabiliser system

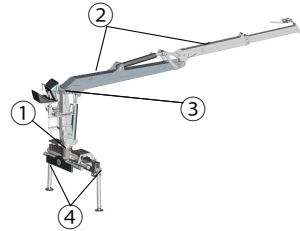

2.2. Crane base with column and slewing system

The crane base, column and the slewing system consist of the following components:

- Crane base
with stabiliser beam, column bearings and three-point bridge.
- Column
is fitted to the crane base and turns in an upper and a lower bearing.
- Slewing system

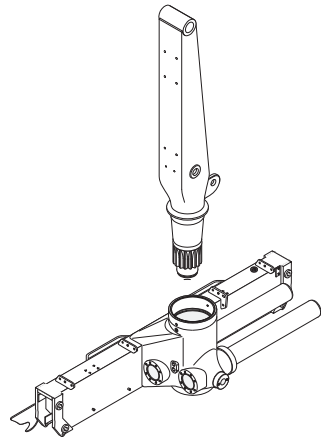

2.3. Boom system and add-on lifting accessories

The boom system consists of the following components:

- 1st boom (1)
- 2nd boom (2)
- Hydraulic extensions (3)

The length of the hydraulic extension depends on the type of crane.

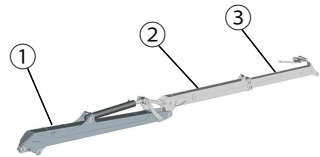

Add-on lifting accessory is placed between the boom tip and the load.

2.4. Stabiliser system

All our cranes are equipped with two stabiliser extensions and two stabiliser legs. Auxiliary stabiliser systems may be needed for heavy cranes.

- (1) Stabiliser beam. The stabiliser beam is a part of the crane base.
- (2) Stabiliser extensions.
- (3) Stabiliser locking device.
- (4) Stabiliser leg.

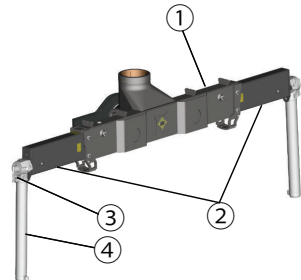

2.5. Operating system - hydraulic components

The operating system consists of the following hydraulic components:

- oil tank
- hydraulic pump
- oil cooler [option on some cranes]
- main control valve
- stabiliser control valve
- hydraulic hoses and lines
- actuators:
 - first boom cylinder
 - second boom cylinder
 - extension cylinder/s
 - slewing cylinders
- return filter/oil tank
- pressure filter

2.6. Buttons on the control panel [option]

Control the stabiliser system from the high seat [option]

The crane and the stabiliser system can be operated from the high seat.

- (1) Stabiliser leg, left
- (2) Stabiliser leg, right
- (3) Stabiliser extension out/in
- (4) Console or optional function
- (5) Bunk movement
- (6) Lights
- (7) Load weighing device [option] / activation of the main control [HPC option]
- (8) Seat heat [option]
- (9) Button to be used together with (1), (2), (3)
- (10) Optional button

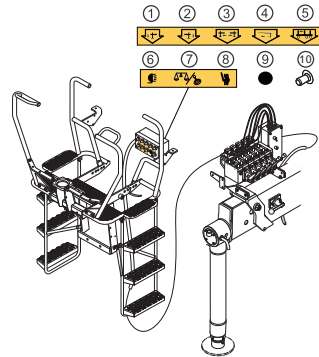

DANGER

Take care not to put your foot on the pedals when taking place in the high seat. Unintentional crane movements can occur.

Before leaving the high seat, switch off the system from the control panel, deactivate the main control (HPC).

2.7. Premium high seat [option]

- (1) Handle to adjust seat forward/backward
- (2) Seat belt
- (3) Handle to adjust height of the seat
- (4) Locking device for seat tilting
- (5) Handle to adjust armrest

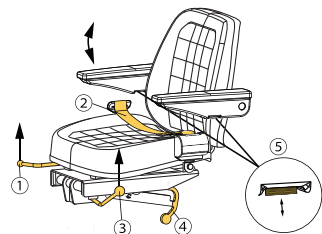

DANGER

For cranes with joysticks and HPC, always deactivate HPC before leaving the high seat.



DANGER

Take care not to put your foot on the pedals when taking place in the high seat. Unintentional crane movements can occur.

2.8. Cabin [option]

- (1) Front door
- (2) Protective curtain
- (3) Work lights
- (4) Side door
- (5) Warning light
- (6) Service hatch
- (7) Heater/cooler
- (8) Control panel

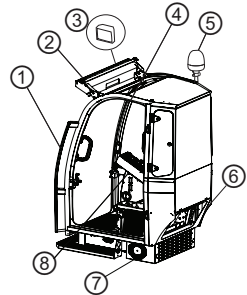

2.8.1. Control panel in the cabin C912



NOTE

The top on the control panel depends on the selected heating/cooling system. For diesel heater, see section diesel heater.

- (1) Electric Control (Stand by)
- (2) PTO
- (3) Stabiliser extension in/out
- (4) Left stabiliser leg in/out
- (5) Extra button
- (6) Cabin up/down
- (7) Work light, crane boom
- (8) Work light, roof
- (9) Windshield washer
- (10) Wiper
- (11) Extra button
- (12) Blind plug
- (13) Switch for diesel heater [option]
- (14) Right stabiliser leg in/out
- (15) Stop button
- (16) Extra button
- (17) Over load warning
- (18) Warning light
- (19) Button to be used when operating the stabiliser system
- (20) 12V outlet
- (21) Seat heater

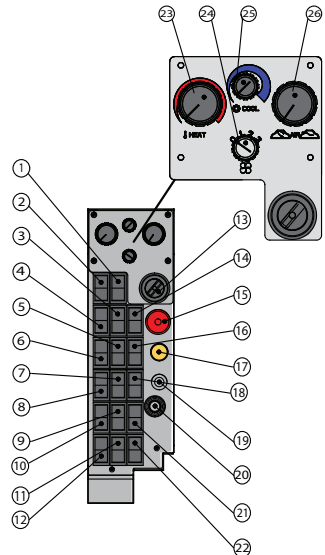

- (22) Blind plug
- (23) Heater [option]
- (24) Fan [option]
- (25) AC [option]
- (26) Air mix [option]

2.8.2. Control panel in the Hi-Cab



NOTE

The top on the control panel depends on the selected heating/cooling system. For diesel heater, see section diesel.

- (1) Electric Control (Stand by)
- (2) PTO
- (3) Blind plug
- (4) Left stabiliser leg in/out
- (5) Stabiliser extension in/out
- (6) Right stabiliser leg in/out
- (7) Blind plug
- (8) Cabin up/down
- (9) Extra button
- (10) Extra button
- (11) Blind plug
- (12) Work light, roof
- (13) Work light, crane boom
- (14) Warning light
- (15) Blind plug
- (16) Wiper
- (17) Windshield washer
- (18) Seat heater
- (19) Blind plug
- (20) Activate Webasto remote [option]
- (21) Switch between AC/Heather
- (22) Blind plug
- (23) Blind plug
- (24) Switch for diesel heater [option]
- (25) Stop button
- (26)Over load warning

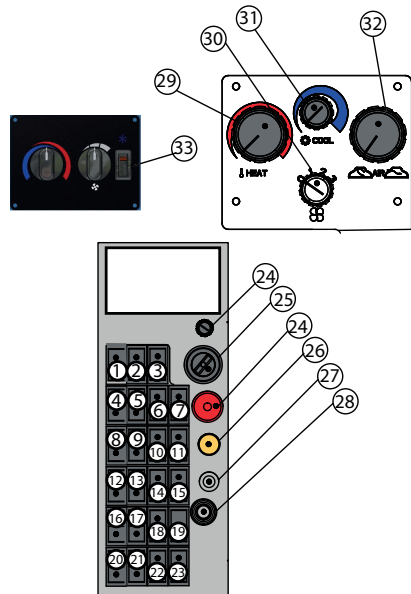

- (27) Button to be used when operating the stabiliser system
- (28) 12 V outlet [option]
- (29) Heater [option]
- (30) Fan [option]
- (31) AC [Option]
- (32) Airmix
- (33) Activate AC

2.8.3. Fuses in the cabin Hi-Cab

F1	15A	Diesel heater, cooler compressor
F2	10A	Work light, outside cabin (15A 12V/Xenon)
F3	10A	Work light, boom system (15A 12V/Xenon)
F4	10A	Wiper, washer, work light inside cabin
F5	10A	Control panel
F6	10A	CE box Diesel heater
F7	10A	Weigher
F8	10A	Lighter
F9	10A	Cooler
F10	20A	AC
F11	10A	Spare fuse
F12	10A	Spare fuse

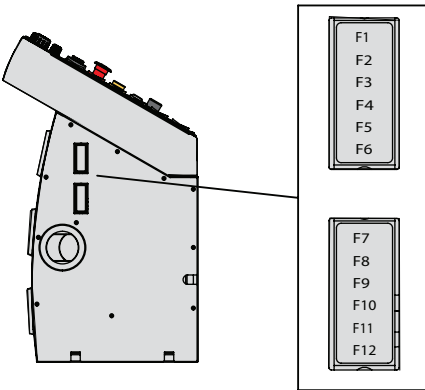

2.8.4. Fuses in the cabin C912

F1	40A	Diesel heater, cooler compressor
F2	10A	Work light, outside cabin (15A 12V/Xeon)
F3	10A	Work light, boomsystem (15A 12V/Xeon)
F4	10A	Wiper, washer, work light inside cabin
F5	10A	Control panel
F6	10A	CE box Diesel heater
F7	10A	Scale
F8	10A	Lighter
F9	10A	Cooler

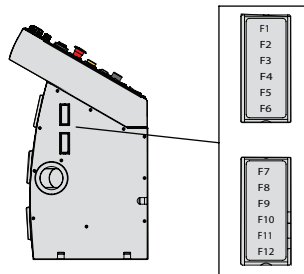

F10	10A	Cooler compressor
F11	10A	Spare fuse
F12	10A	Spare fuse

2.9. Main control valve

Near each lever there is a sticker with a symbol. The symbol illustrates the function of the lever. Always operate the lever according to the symbol sign.

The speed of a function corresponds to the extent of the lever movement, regardless of the load and other functions, as long as the oil flow is sufficient. When the oil flow is insufficient, one or more functions might reduce their speed.

2.10. Stabiliser control valve

The crane is equipped with a stabiliser control valve. The valve can be operated with the levers on the valve and from the high seat/cabin [option]

There are several types of stabiliser control valves. Always operate the lever according to the function on the symbol sign.

The symbol is shown either on the lever knob or on a separate sign placed vertical/horizontal next to the lever.

- **Stabiliser extension (1)** out/in
- **Stabiliser leg (2)** upward/downward

The stop button affects the oil supply to this valve.

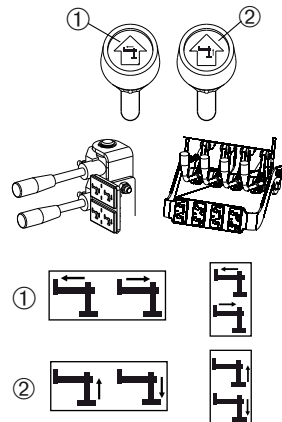

Operate the stabiliser extensions and stabiliser legs.

From the high seat:

Press and hold the button (3) at the same time.

From the cabin:

Press and hold the button (4) at the same time.

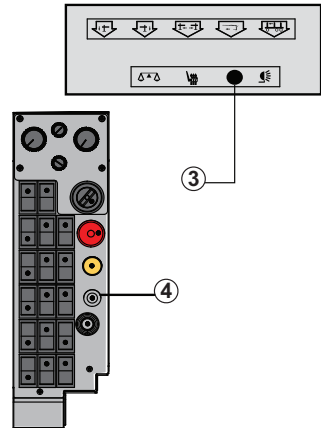

3. Safety precautions and warnings

3.1. Operating conditions

You may only use the crane under the following conditions:

- In the open air, or in spaces with sufficient ventilation.
- With a mean wind velocity less than 13.3 m/sec (approx. 29.7 mph).



DANGER

- If you use the crane in a confined space you could suffocate from the exhaust gases from the vehicle.
- **Never** use the crane at temperatures below -40°C (-40°F), as the steel's properties deteriorate below this temperature.



WARNING

- If the temperature is below 0°C (32°F) we recommend you to wait a few minutes before you operate the levers
- When starting in cold weather, the wear on the hydraulic system is greater than at normal working temperatures.



To minimise wear, the crane should be started as follows:

- Engage the power take-off at low rpm.
- Allow the system to idle for a few minutes.
- Fixed pump:
Operate the stabiliser leg up for one minute in order to warm up the oil.
- Variable pump:
Operate stabiliser legs up and down for one minute, in order to warm up the oil.

3.2. Wind speeds

Wind speed averaged over 10 minutes at a height of 10 m

Wind Force	Above flat ground		Characteristics
	m/s	Wind type	
0	0.0 - 0.2	Calm	Calm, smoke rises vertically or nearly vertically
1	0.3 - 1.5	Slight breeze	Wind direction recognisable from smoke plumes, the wind begins to be noticeable on the face; leaves begin to rustle and weather vanes can start to move.
2	1.6 - 3.3		
3	3.4 - 5.4	Moderate wind	Leaves and twigs in continuous movement, small branches begin to move. Dust and paper begin to move over the ground.
4	5.5 - 7.9		
5	8.0 - 10.7	Fairly strong wind	Small leaved branches make swaying movements; crested waves form on lakes and canals.
6	10.8 - 13.8	Strong wind	Large branches move; you can hear the wind whistling in telephone wires; umbrellas can only be held with difficulty.
7	13.9 - 17.1	Severe wind	Entire trees move; the wind causes difficulty when you walk into it.
8	17.2 - 20.7	Stormy wind	Twigs break off, walking is difficult.
9	20.8 - 24.4	Storm	Causes superficial damage to buildings (chimney pots, roof-tiles, and TV antennae are blown off).
10	24.5 - 28.4	Severe storm	Uprooted trees; considerable damage to buildings etc. (occurs infrequently on land).
11	28.5 - 32.6	Very severe storm	Causes extensive damage (occurs very infrequently on land).
12	> 32.6	Hurricane	

3.3. Noise declaration

The following values for emitted noise may be taken as general and conservative values for ordinary installations of loader cranes on normal diesel engine powered trucks. Declared dual-number noise emission values in accordance with ISO 4871:

- Emitted A-weighted sound power level for basic loader cranes in accordance with ISO 3744: LwA = 103 dB (Uncertainty: KwA = 2 dB).
- Emitted A-weighted sound power level for loader cranes with hoist in accordance with ISO 3744: LwA = 107 dB (Uncertainty: KwA = 2 dB).
- A-weighted sound pressure level at loader crane control stations in accordance with ISO 11201: LpA = 95 dB (Uncertainty: KpA = 4 dB).

Load plate

On the plate is the maximum weight that you may lift at a given reach, with the 1st boom in the optimum position. In chapter Technical Data in this manual you will find these values for your crane.

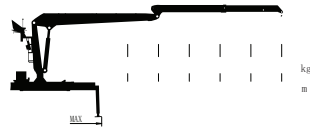

DANGER

Never exceed the maximum weight on the load plate.

Load diagram

The load diagram shows the maximum load your crane may lift in the entire working zone.

The load curves show the maximum load that may be lifted at a given reach and height. For a given maximum load, the possible working zone is to the left of the load curve. The lifting capacity for some cranes is limited in the high lifting area.

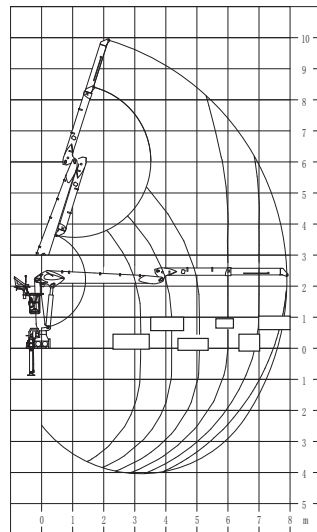

WARNING

Care must be taken when handling loads in the high lifting area, so the load/tool does not come into contact with the boom system.

3.6. Signals when using a crane



DANGER

- If it is not possible to see the load and the entire working area clearly the crane operator is obliged to follow the instructions and signals given by a qualified person.
- The country-specific regulations for crane operator signals are to be used.

Signals in this manual give a number of standard signals that can be used.

Lift

Raised arm and index finger raised. Circular motion with the hand.

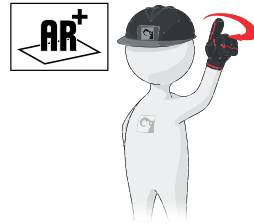

Lower

Arm pointing downwards and index finger down. Circular motion with the hand.



Stop all crane movements / Hold the load in position

Raise the open hand, with the palm clearly visible, and arm at shoulder height.

Keep the hand still.



Emergency stop for all movements by the crane

Raise the hands and the arms to an oblique angle.



Very short movement

Place the hands a very short distance apart, with the palms facing each other. The hands may be held either horizontally or vertically. The next movement may be: Lift, lower, move the lifting gear, change the reach, or turn.

**Change the reach**

Signal with your hands.

- Sideways movement outwards with both hands. Thumbs outwards.
- Sideways movement inwards with both hands. Thumbs inwards.

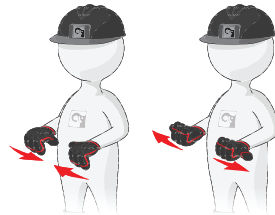
**Turn in the direction indicated**

Indicate the direction with the hands.

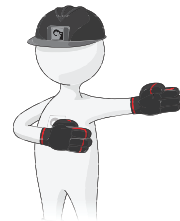
**Open the tool**

Extend the arms at shoulder height, with the palms facing downwards.

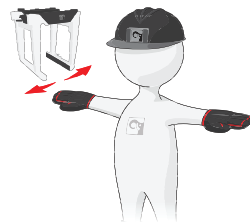

Close the tool

Move both hands close together.

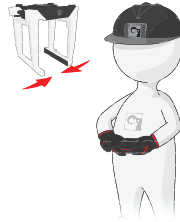
**Lift the open tool a little**

Extend both arms at shoulder height, with the palms facing upwards. Make vertical movements with both arms outstretched.

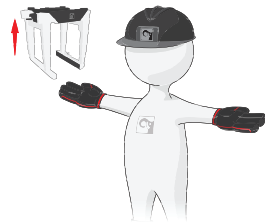
**Keep the tool in position briefly**

Raise the hand drooping slightly, with the fist clenched.



3.7. Use of the crane

Starting crane operation



DANGER

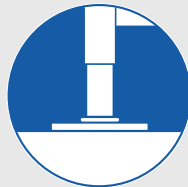

- Wear a safety helmet (compulsory in some countries!).
- Check that the ground is sufficiently flat and firm.
- To ensure that the vehicle stays in its position, always engage the parking brake and place chocks under the wheels.
- Check that the ground is not undermined. Look out for sewers, cellars, excavations etc.
- The stabiliser legs must not be able to sink in! Use support plates that are large and firm enough for your crane. The plates must not bend under load. Check that the support plate as, it comes under load, is not pushed into the ground.
- Ensure you can see the stabiliser legs and stabiliser extensions when you are operating them.
- Do not lower the stabiliser legs on the edge of an embankment, soft shoulder, slope etc.
Lower the stabiliser legs only on to a flat and firm surface.



DANGER

- Do not stand in front of the hydraulically operated stabiliser legs when you are operating them!
- Never use the stabiliser legs as a parking brake, since the vehicle could start to slide.
- Slide the stabiliser extension, on both sides of the vehicle, out completely if possible. Then lower the stabiliser legs for support.
- Never operate the stabiliser legs, while the crane has a load!





WARNING

- Use low force when placing the stabiliser legs on the ground.
- Do not raise the vehicle with the stabiliser legs!
If you raise the vehicle with the stabiliser legs, this may damage the stabiliser legs.



DANGER

Do not stand in front of the boom system when operating the crane out of the parking position.

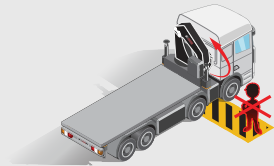

Preparation for use



WARNING

Make sure that there are no unauthorised persons within the operating range of your crane!



WARNING

- If a part of the crane comes in contact with an electricity line, you will be electrocuted!
- Maintain the following minimum distances between the crane and overhead electricity lines, unless otherwise prescribed by national rules.

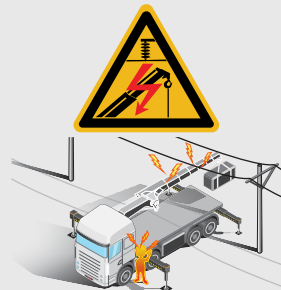

Minimum distance between crane and over head electricity lines		
Voltage (V)	Minimum distance to an insulated conductor	Minimum distance to an uninsulated conductor
<500 V	0.5 m	2 m
500-40000 V	1.5 m	4 m
>40000 V	2.0 m	6 m
Voltages are found:		
up to 500 V:		to buildings
500-40000 V:		trams, trains
over 40000V:		power transmission

**DANGER**

When you go into the control station (high-seat, cabin, platform) remove all jewellery, loose clothing or other hanging items from your body (for example, rings, scarfs, bracelets...). Jewellery, loose clothes and other hanging items can be caught in some parts of the crane.

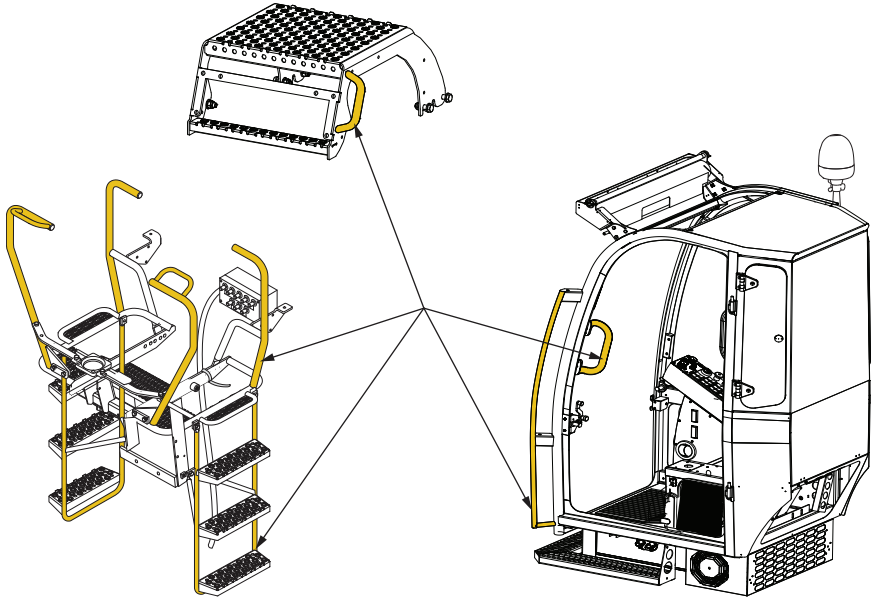
**DANGER**

When you go into or out from the control station, use only handles and supports on the crane that were specifically made to help the operator to go into or out from the control station.

Safety when starting crane operation



DANGER

- Ensure you can see the stabiliser legs and stabiliser extensions when you are operating them.
- Do not stand in front of the hydraulically operated stabiliser legs when you are operating them!
- Where the ground is not firm enough, use support plates under the stabiliser legs for additional support.

Use support plates that are large and firm enough for your crane.

Check that the support plate as it comes under load, is not pushed into the ground.

Check that the support plate does not bend under load.

- Do not lower the stabiliser legs on the edge of an embankment, soft shoulder, slope etc.
Lower the stabiliser legs only on to a flat surface.
- Slide the stabiliser extension, on both sides of the vehicle, out completely if possible. Then lower the stabiliser legs for support.
- Never operate the stabiliser legs, while the crane has a load!



WARNING

- Use low force when placing the stabiliser legs on the ground.
- Do not raise the vehicle with the stabiliser legs, if the crane is equipped with only two stabiliser legs!

If you raise the vehicle with the stabiliser legs, this may damage the stabiliser legs.

Safety during crane operation



DANGER

The crane has a safety system.

The safety system will help the operator to work safely. Nevertheless, the operator remain responsible for safe use of the crane!

Therefore, always work according to the operating instructions!

In an emergency immediately switch off all crane movements!

- Press a **stop button**.

To avoid unexpected load movements and at every interruption in crane operation.

- Press a **stop button**

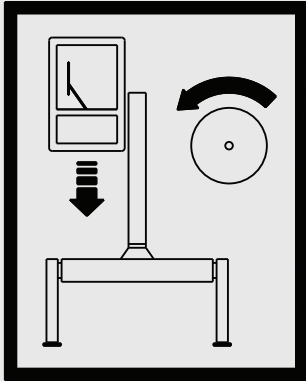

DANGER

- Keep checking that there are no unauthorised persons within the operating reach of the crane!
- For cranes with cabin; if something is wrong with the crane when the cabin is in the upper position, use the valve for emergency landing and the cabin will go down slowly. The valve for emergency landing is located on the right side of the seat, next to the lever.
 
- Always close the front door when you are inside the cabin. The side door must be closed or locked in ventilation mode.
- Maximum 1 person in the cabin!
- Make certain that you can always see the load!
- Make sure you have a clear work area. No person is allowed in a 20 m radius.
- Never move the vehicle, if you have a freely-suspended load on the crane!
- Never walk or stand under a suspended load!
During operation, never stand below the boom system or load!
- Do not slew the crane, nor lift the first boom, nor lift the second boom into their ends positions at full speed. This can damage the crane.



WARNING

- Never use the extension boom as a jack. This could damage the slewing bearings and the connection between the crane column and the crane base.
- Do not lift a load above yourself or the cab.
- Be careful, in particular, the safety system gives an early warning!
- When loading the vehicle:
Take the load off the stabiliser legs by withdrawing them slightly. The stabiliser legs must remain in light contact with the ground.



CAUTION

- Operate the crane using smooth and gentle lever movements.
- If a cylinder is at its end position, free the operating lever. Otherwise overheating can occur.

3.7.1. Use of lifting equipment



DANGER

- Only use lifting accessories that are suitable for your crane. Contact a HIAB service workshop.
- Never attempt to install add-on lifting accessories yourself!
- Add-on lifting accessories may only be installed by an authorised HIAB service workshop.
- When using lifting accessories, follow the instructions supplied with the equipment!
- Watch out for hazards!
- Never try to adjust lifting accessories when you are working on the crane!

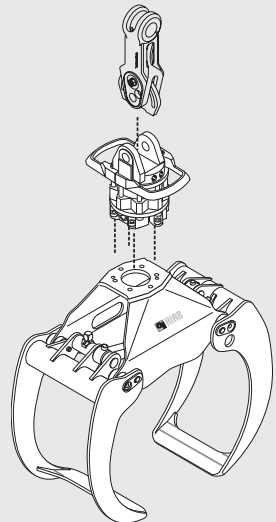

After the lifting accessories have been fitted:

1. Check that the lifting accessories are securely fixed.
2. Only after this should you use your crane.



WARNING

- Clean the couplings, when connecting and disconnecting lifting accessories. Dirt can damage the hydraulic system.
- Take care that your fingers are not trapped

Safety when ending crane operation



DANGER

Always end crane operation as follows:

- After use, always place the crane in the transport position!
- When you have to park the boom on the load space or over the load; secure the boom and the lifting accessories to prevent any movement of the crane and the lifting accessories.
- Withdraw the stabiliser legs and stabiliser extensions.
- Lock tiltable stabiliser legs and manual operated stabiliser extensions in transport position.
- Check that the locking mechanisms are properly locked.
- Switch off the operating system.
- Disengage the PTO or power supply after work.
- If you drive with the PTO or power supply engaged, this will cause serious damage to the PTO/gearbox combination.



DANGER

For cranes with cabin:

- Make sure that the cabin is in lower position.
- Close all windows and both doors.
- Pull down the protecting curtain to protect the front door .

Only after doing the above, should you drive the vehicle away.

3.7.2. Use of dismantable cranes



DANGER

- Ensure that there are no unauthorized persons in the immediate vicinity of the crane. When mount/dismount the crane to the vehicle people can suffer fatal crushing injuries!
- After setting up:
Check that the crane is properly locked!

Dismounting the crane

1. Make sure that the ground where the crane will be parked is firm.
2. Fully extend and set the stabilisers to ground.

3. Park the crane straight backward with a piece of wood underneath the crane tip to prevent damage.
4. Disconnect the power take off to ensure that the hydraulic system is without pressure.
5. Disconnect the crane from the chassis.
6. Slowly drive the vehicle away from the crane.

**WARNING**

Take care when mounting/dismounting the crane on/off the vehicle.
Roughly handling can seriously damage the crane or the vehicle.

Driving with the crane**DANGER**

- Never drive the vehicle if there is a load suspended from the crane.
- Before you move the vehicle:
Check that there is no pump flow to the main control valve. The PTO or power supply must be disengaged. The operating system must be switched off!
- Pay attention to the width and height of the crane in the transport position. The crane has to stay within the width of the truck. Make sure the parked crane can not hit bridges, tunnels etc.
- Pay attention to overhead power lines!
Make sure that no part of the crane ever comes in contact with overhead power lines.

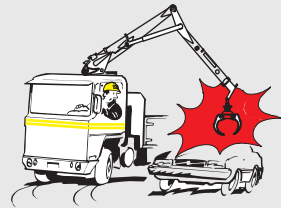

For further instructions see vehicle's manual(s).

4. The CE system [option]

4.1. How the CE system works

The crane is equipped with the CE-safety system. The CE-safety system will help you to operate the crane safely.

The system will:

- monitor the crane operation and prevent unsafe actions
- make the operation easier
- make troubleshooting easier

In dangerous situations always press a stop button.

This will happen:

- The truck engine is stopped. (depending on the version of the CE-system).
- If the crane is equipped with dump valves the oil is dumped directly to tank.

4.2. Components in the CE System

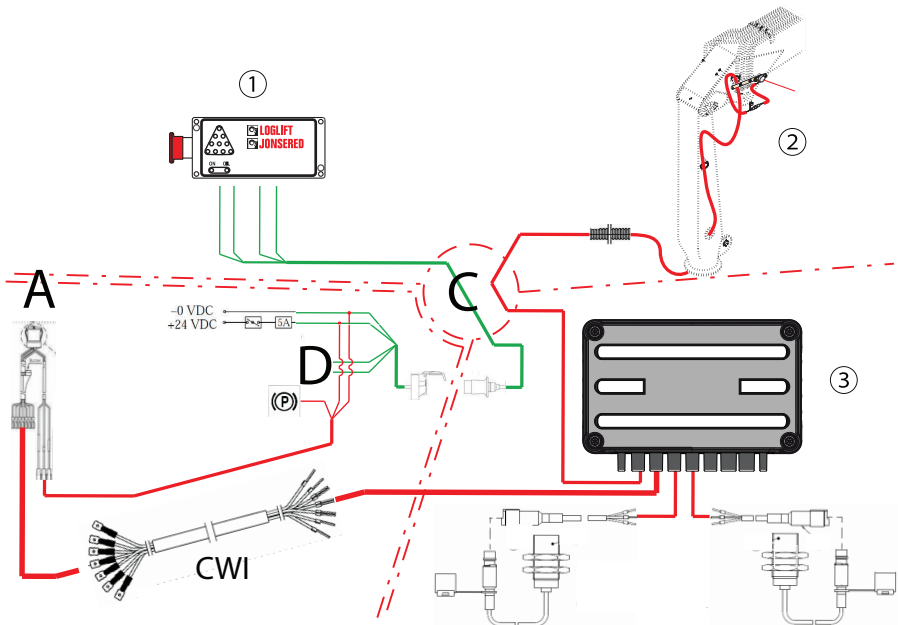

- **A:** Cabin warning interface in the vehicle (CWI)
- **C:** Crane column
- **D:** Engine stopper [option]

Interface (1)

- The interface receives and analyses signals from sensors and switches placed on the crane. Inside the interface there is a numerical display that shows error codes.

Tilt indicator (2)

- The tilt sensor sends information about the first boom position to the TWI .

Pressure sensor

- The pressure sensor measures the pressure in the first boom cylinder and it is located near the main control valve.

Transport warning (3)

- The transport warning receives information if the first boom is in high position or if the stabiliser extensions are not in locked position when moving the vehicle. A signal is then send to the warning interface, placed inside the vehicle cab. The interface will warn the operator.

Dump valves

- The dump valves controls the oil in the hydraulic system depending on signals from the electric unit. If the dump valve is open the oil will go directly to tank.

NOTE! If the CE- system controls the engine there is no dump valve on your crane .

4.3. Buttons and indicating lights on the interface

Stop button (1)

- If a danger situation occurs, press the red stop button on the interface. Depending on the version of the CE system, the truck engine stops or the dump valve on the crane will open and the oil will return directly to the hydraulic tank. When the stop button is pressed the orange light (2) will switch off and the load warning lamp (4) will flash.

To release the stop button, turn it clockwise. When the button is released the orange light will switch on.

WARNING! If the stop button is released the cranes hydraulic circuit is restored.

On cranes with cabin the stop button is located on the cabins control panel. On cranes with high seat it is placed in front of the seat.

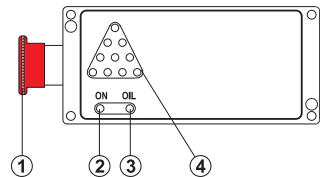

Lamp indicator for supply voltage (2)

- When the lamp is lit green the system is on.

Lamp indicator for oil pressure (3)

Lamp indicator for over load (load warning) (4)

- When the load reaches 90% of permitted load the warning lamps will flash. When 100% of maximum permitted load is reached the warning lamp will light up.
- If the crane has an error or the stop button is pressed the warning lamps will flash differently, see the table below.

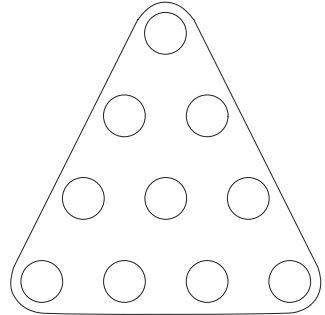

Situation	Flash code
90%
100%	_____
Error code	- - - - -

5. Manual control system [option]

5.1. Operation from the high seat

The high seat is equipped for using tools and it is operated by two or four control levers and two foot pedals.

For safety reasons, it is necessary to sit down on the seat to operate the control levers.

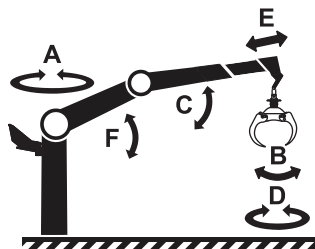

A: Slewing

B: Grapple

C: 2nd boom

D: Rotator

E: Extension

F: 1st boom

Two control levers and two footpedals (2+2)

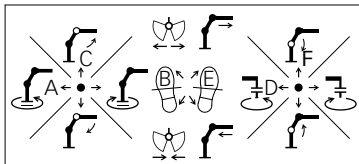

Four control levers and two foot pedals (4+2)

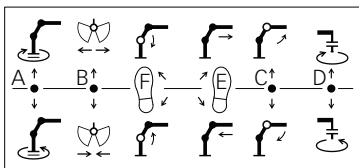

Five control levers and one foot pedal (5+1)

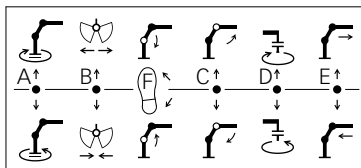

DANGER

Take care not to put your foot on the pedals when taking place in the high seat. Unintentional crane movements can occur.

5.2. Manual operation from cabin

The cabin is equipped with two or four levers and two foot pedals.

A: Slewing

B: Grapple

C: 2nd boom

D: Rotator

E: Extension

F: 1st boom

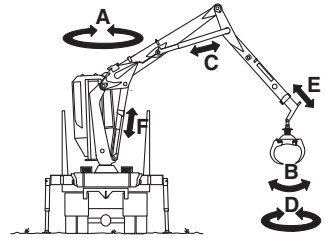

Two control levers and two foot pedals (2+2)

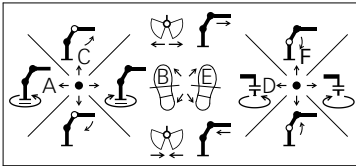

Four control levers and two foot pedals (4+2)

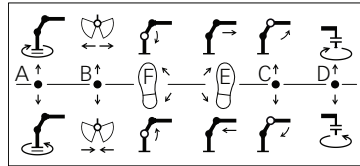

6. HPC [option]

Hydraulic Pilot Control (HPC) is an optional control system that gives you smooth and easy operation.

- Precision control over your crane movements
- Smooth, flawless operation.
- Reduced stress on crane structure
- Increased life expectancy of your equipment

With 2 or 4 joysticks.

Adjust the joysticks, High seat

1. Release the lower wheel by turning it counter clockwise.
2. Adjust the height of the joystick.
3. Lock the lower wheel by turning it clockwise.
4. Release the upper wheel by turning it counter clockwise.
5. Adjust the angle of the joystick.
6. Lock the upper wheel by turning it clockwise.

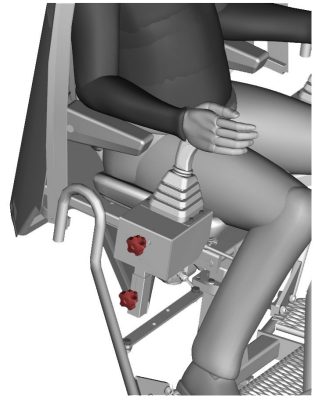

Adjust the joysticks, Cabin

1. Release the lower handle.
2. Adjust the height of the joystick.
3. Lock the lower handle.
4. Release the upper lever.
5. Adjust the angle of the joystick.
6. Lock the upper lever.

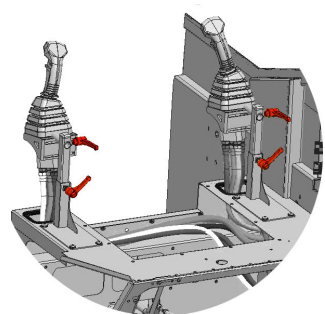

7. The control system TimberTronics [option]

7.1. The TimberTronics control system

The TimberTronics control system is developed for Loglift and Jonsered. With the TimberTronics control system you can:

- Monitor the crane's operating data
- Display error messages and operational warnings
- Troubleshoot easy

The control system also provides integrated weighing, showing how heavy load is being handled at any time [option].

Press the standby button on the cabins control panel to start the system. For safety reasons, the joysticks are blocked when the system is started. Press a menu button on a joystick to activate them.

7.2. Components in the TimberTronics system

- (1) Two joysticks (placed inside the cabin)
- (2) MASTER unit box (placed underneath the cabin)
- (3) CRANE unit box (placed underneath the cabin)
- (4) Display (placed inside the cabin)
- (5) Ground Control Unit (GCU) [Option]
- (6) Regulators (placed on the control valve)

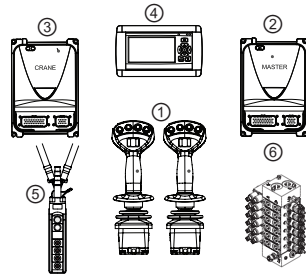

The system has two operating mode.

Stabiliser mode is used for cabin up/down and to operate the stabilisers.

Crane mode is used to operate the crane.

Use the MENU buttons on the joysticks to step between the modes. Present mode is shown on the display.

Joysticks, steering schema

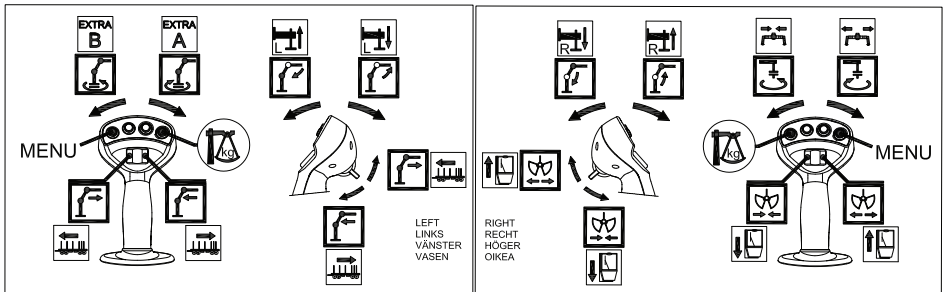

7.3. Display

With the display unit the status can be monitored and the functionality can be adjusted. The system needs to be on for the display to light up. It is also possible to save different driver profiles.

From the main menu the operator can step through different submenus by using the buttons on the display.

**TIP**

Make your personal adjustments to achieve the best performance.

Buttons

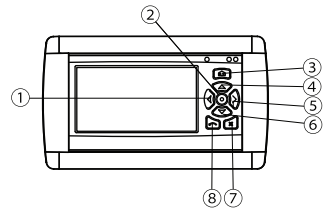

- (1) Arrow left
- (2) Enter/OK
- (3) Main menu
- (4) Arrow up
- (5) Arrow right
- (6) Arrow down
- (7) X (Shortcut to submenu)
- (8) Back (Shortcut to submenu- weighing)



Main menu





This is the first menu displayed when the system is started. For cranes with scale a truck with the different load zones are shown together with the accumulated total weight. .

Main menu- Scale [option]

When the button for scale, on the joystick, is pressed and a stable weight is detected the background will turn black. When the load is released the weight is added to the accumulated total weight. The measurement can be undone by pressing the scale button again and hold it down for two seconds. Use the arrows   to step between the different load zones

To adjust the weight measuring, press the button .

Main menu- Change driver

Three different driver profiles are available. To change between the profiles, press the button , and the indicator for selected driver starts to blink. Use the arrows   to change driver, press button  again to save. Press the button  to undo. Driver number 1 is always programed with the factory settings and cannot be changed.

Main menu- Characteristics of the crane



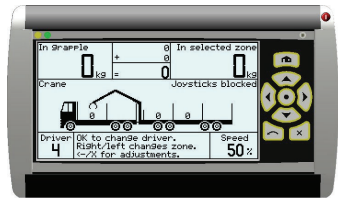
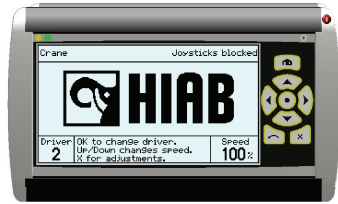

The characteristics of the crane can also be altered via the buttons  which can be used to reduce the speed of slewing, lifting and tilting. All fuctions can be adjusted from 50-100%

From this menu It is possible jump to the submenus, press the button .

Use the button  to return to the main menu.



Submenus

Press  from the main menu. In these menus the behavior of the crane, sensitivity of the joysticks, language, driver and scale functions can be adjusted. Select function with the arrow buttons   and press the button  to start.

Adjust crane speed and ramps

Select crane function to adjust by moving the joystick in the desired direction.

Example –slew left

In this menu it is possible to adjust speed so called ramp up och ramp down. Navigate with the arrows to select the a field.

To change the maximum speed, navigate to (1) and change the desired speed with . A higher value means faster crane.

To adjust the start ,the ramp up, navigate to (2)and adjust the value with . A higher value gives smoother start.

To adjust the stops , the ramp down, navigate to (3) and adjust the value with . A higher value gives smoother stops.

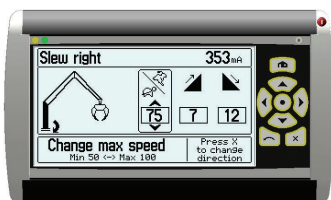
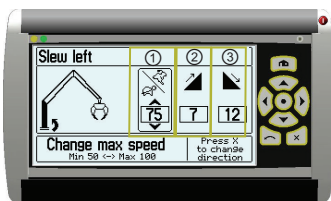
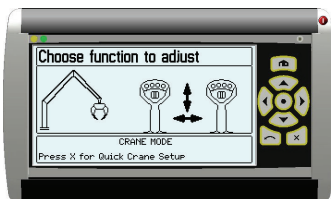
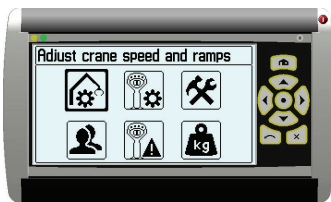

Press  to change direction.

When the adjustment is complete, press  to go back.



Joystick adjustment- sensitivity



Select the icon for joystick response, press  to start.

Use the arrows   to select the wanted joystick function, There are eight steps, 0-7 where a low value gives a function that is more responsive and fast in the beginning of the lever stroke. A high value gives higher finecontrol and slower control at low lever stroke.

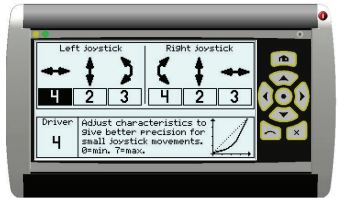
Confirm with the button . An "!" before the function indicates the new direction.





Scale – Tare

The settings for scale are divided into four screens which can also be reached by pressing button  from the main menu. Use the arrows   to navigate between the submenus.

Reset the cranes dead weight by pressing button .



TIP! Reset when the crane is hanging free without load.

Weight - Reset

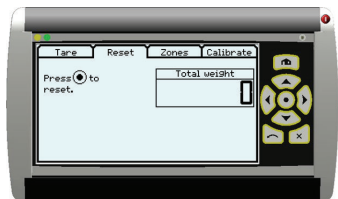
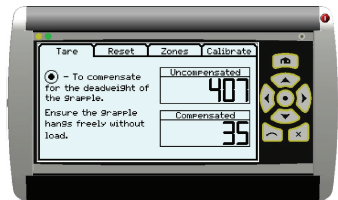
In this menu the accumulated weight can be reset by pressing button . This can also be done from the main menu by pressing button  twice.



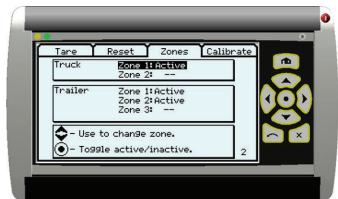

Weight – Load zone selection

Select which load zones to be active with the arrow buttons  . Confirm with the button .



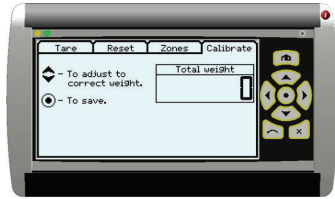

Weight - Calibration

This menu is used to calibrate the weight. If there is a mismatch comparing with the scale on the vehicle use arrows  to adjust the weight. Confirm and save with the button .





Change language

Use this menu to change the language used in the display. Select the wanted language with the arrows  and confirm with the button . A restart is needed before any changes can be seen.



Copy driver settings

Copy settings from another driver. Select a driver to copy from with the arrows  and confirm with the button .

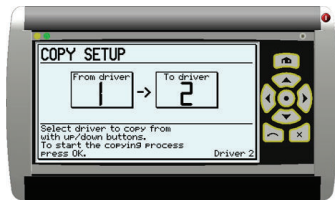
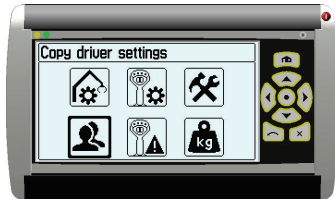

LEDs for indication of the system's operational status

All units in the TimberTronics system are equipped with two LEDs (1) to indicate operational status;

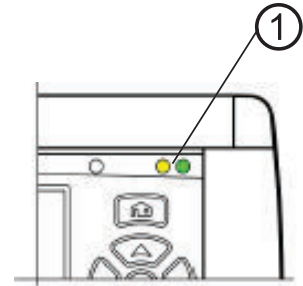
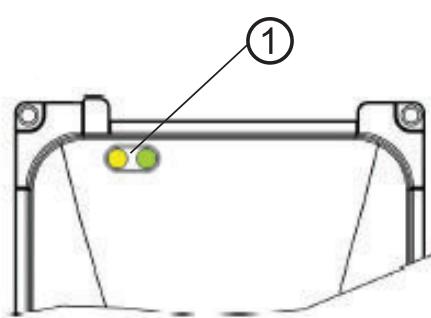

LED status	CAN status (yellow)
OFF	Unit lacks power or will not start.
Slow flash	No communication via CAN-bus.
Rapid flash	Fault in CAN-bus communication in the unit. For the Master-unit: Fault in Master unit's CAN-bus communication or in another part of the system.
Steady glow	CAN-bus communication works normally for the unit. For the Master-unit: CAN-bus communication works normally for the entire system.
LED status	CPU status (green)
OFF	Unit lacks power or will not start.
Slow flash	Standby position or configuration position.
Rapid flash	Internal fault in the unit. For the Master-unit: Fault in the Master unit or in other units connected to the system.
Steady glow	Unit works normally. For the Master-unit: The entire system works normally

Ground Control Unit (GCU) [option]

The GCU- unit is a controller used together with the TimberTronics control system. The GCU is connected to the crane via a cable.

When the GCU is connected, all levers on the main control valve will be locked and the crane is operated with reduced speed.

(1) Stop button

(2) Button to be pressed when using the crane operating buttons.

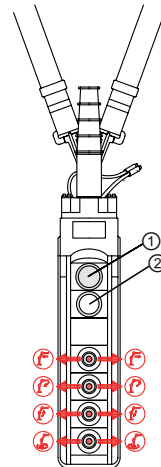
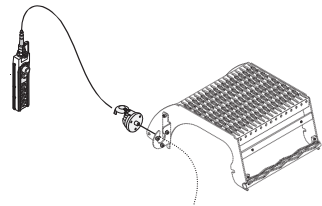

**NOTE**

To operate the crane with the controller, press and hold the button (2) at the same time,

**CAUTION**

Keep the remote control away from water. Store it inside the cabin when it is not used.

8. The control system Multidrive2 [option]

8.1. The control system Multidrive2

The MultiDrive2 control system is a control system used in Jonsered and Loglift cabin cranes. With the MultiDrive system you can:

- Monitor the crane operating data
- Save different user profiles

8.2. Components in the Multidrive2 System

Components in the MultiDrive2 system

Control levers (placed inside the cabin)

PDF box (placed on the crane)

Display (placed inside the cabin)

DA modules (placed on the main control valve and on the stabiliser control valve)

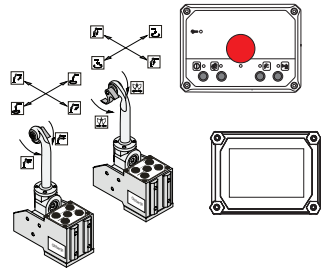

8.3. Multidrive2 control levers and display

Press the standby button on the cabins control panel to start the system. The Multidrive2 control system consists of two control levers, each control lever consists of five buttons.



NOTE

The buttons "SPEED" and "CHANGE" are lever specific. The buttons on the right lever controls the settings for the right lever and the buttons on the left lever controls the settings for the left lever.

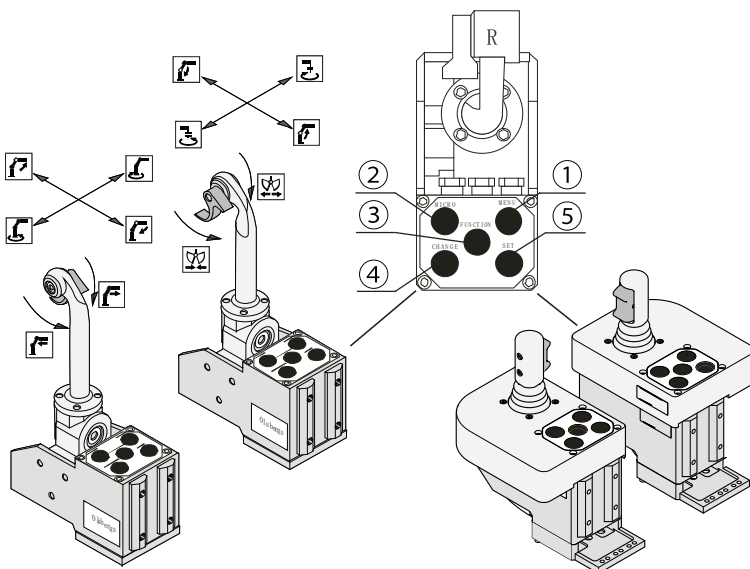

- (1) MENU
- (2) MICRO
- (3) FUNCTION
- (4) CHANGE
- (5) SET

With the Multidrive2 display unit the status of the crane can be monitored and the functionality can be adjusted. It is also possible to see error codes and save different driver profiles. Press MICRO button (3) and the text STAND BY will appear.

**DRIVER 1
STAND BY**

Main menu

The Multidrive2 operating system has the following adjustable parameters:

DRIVER X = User settings; It is possible to save 5 different (1-5) user settings for each driver.

SPEED = Speed settings; Each DRIVER can have there own adjustable speed settings. Speed settings are adjustable from 50 to 100%, in 5% increments. 100% speed means that the job will be performed at maximum speed.

DELAY = Delay settings; Each DRIVER can have there own adjustable delay setting The settings can be adjusted from 0 - 4 (0 = without delay).

Navigate in the main menu via the CHANGE button (4). To confirm a choice and proceed to the next menu press the FUNCTION button (3).

Choose the parameter settings with the CHANGE (4) button. To return to the previous menu, press SET button (5).

DRIVER

When choosing DRIVER the display will show the number of the driver, in this case "driver number 1", and the current driver settings. To change driver settings, press the CHANGE button (4) until the wanted settings appears on the display. Press the SET button (5) to confirm your choice. To return to the main menu, press the SET button (5) again

SPEED

When choosing SPEED the display will show the number of the driver and an arrow for each lever movement. The current speed settings for each arrow is also shown. Move the lever to select the movement to be changed, the selected arrow will turn black. To change the settings for the selected arrow press the CHANGE button (4) until the desired value appear on the display. Confirm with the SET button (5). To return to the main menu, press the SET button (5) again.

DELAY

This menu will show the number of the selected driver, and arrows in different direction with a number for the current delay (0= no delay). Use the control levers to select an arrow, the selected arrow will turn black. Press the CHANGE button (4) to change the value and confirm with the SET button (5). To return to the main menu, press the SET button (5) again.

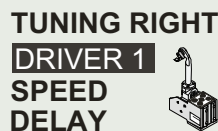

TUNING RIGHT
DRIVER 1
SPEED
DELAY



DRIVER 1

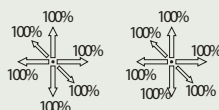

DRIVER 1

SPEED
85%



DRIVER 1

DELAY
2

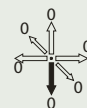

Speed quick set

Each control lever has a MICRO button (2).

If you press the button one time the speed for all movements will drop to to 50% of maximum.

If you press the button twice the speed for all movements will drop to to 20% of maximum.



If you press the button three times the speed for all movements will be 100% (maximum).

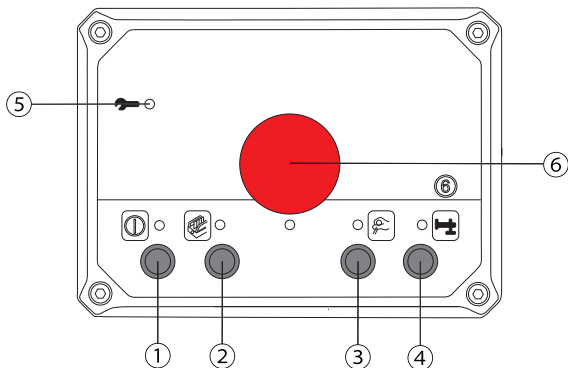

The selected settings will appear on the display.

If a control lever doesn't move for 5 minutes, the operating system switches to Stand By. Press the stand by button on the control panel in the cabin twice to restart the system

8.4. Buttons and indicator lights on the PDF



	<p>Power On</p>	<p>(1)</p>	<ul style="list-style-type: none"> ● Green light on: The system is on. ● Green light flashing: A stop button is pressed.
	<p>Service</p>	<p>(5)</p>	<ul style="list-style-type: none"> ● Green light on: Time to service the crane. ● Red light on: A non-critical error detected in the system. ● Red light flashing: Critical error is stopping the crane. Diagnostic required. ● Red double flash: CAN error, crane stops.

	Control from cabin	(2)	<ul style="list-style-type: none"> ● Green light on: Good connection. ● Green light blinking: Stop button pressed/no connection. ● Red light blinking: Radio interference.
	Manual control	(3)	<ul style="list-style-type: none"> ● Green light on: Manual control.
	Stabiliser system (if installed)	(4)	<p>Extra function for the stabiliser system.</p> <ul style="list-style-type: none"> ● Green light on: The function is ready to use.
	Stop button	(6)	<p>To be pressed in dangerous situations.</p>

9. Starting crane operation

9.1. Starting operations

Placing the vehicle

- Place the vehicle on a flat surface. The maximum permissible slope for your crane is 5°. To determine the incline of the truck check the spirit level, on the crane. When the bubble in the middle of the gauge, the crane is in horizontal position. When the bubble is between the two circles, the crane's inclination is between 0° and 5°. If the slope exceed 5° unintentional crane movements can occur.

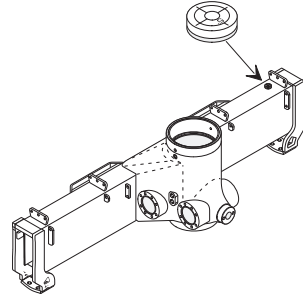

Engage the PTO

- Engage the PTO (Power Take Off).
- Bring the vehicle's engine to the correct rpm.



NOTE

- Rpm too high: the oil in the hydraulic system might overheat. Rpm too low: during crane operation, the vehicle's engine could stall.
- The maximum rpm may depend upon a governor on your PTO combination.

9.2. Attach the crane to the vehicle



DANGER

Always read the console manufacturers instruction before operating the console.



WARNING

Ensure that there are no unauthorized persons in the immediate vicinity of the crane. When attach/removeing the crane to the vehicle people can suffer fatal crushing injuries!

1. Make sure that the ground where the crane will be parked is firm.
2. Fully extend and set the stabilisers to ground.
3. Connect the hoses in the following order:
 - Return hose
 - Pressure hose
 - Rest of the hoses (LS line) and the electric cables
4. Adjust the crane at a suitable height by operating the stabilisers.
5. Reverse the vehicle against the console.
6. Attach the console cylinder lock and the chain.



NOTE

Pressure in the hoses can prevent the quick couplings from connecting: You can release the pressure

- by pressing open the quick-acting coupling's stem
- from the pressure gauge adapter, using a suitable connector.

9.3. Electric tiltable seat [option]

To operate the seat up or down.

Push and hold button (1) and operate the switch (2) at the same time.

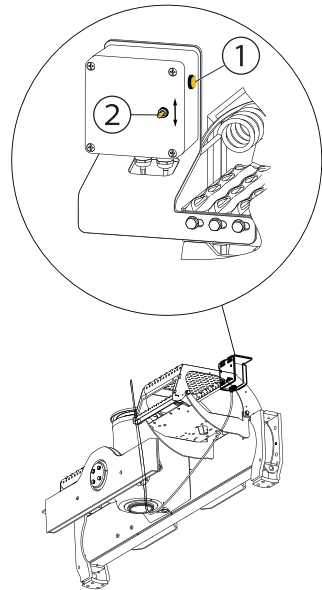

WARNING

Do not stand in front of moving parts. They can cause injuries.

Operating the stabiliser system



WARNING

All levers must be in neutral position.



DANGER

When you are operating the stabiliser extensions: Make sure that you have full view of the stabiliser extensions. Do not stand in front of hydraulically operated stabiliser extensions.

Operate the stabiliser extensions and stabiliser legs.

Press button , if fitted

From the high seat:

Press and hold the button (3) at the same time.

From the cabin:

Press and hold the button (4) at the same time.

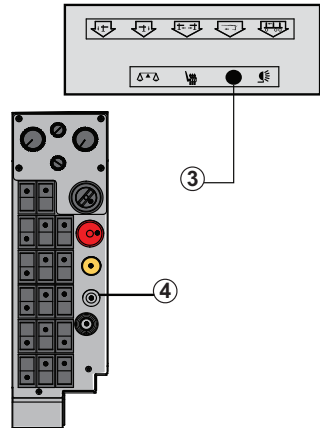

9.4. Extend stabiliser extensions and set stabiliser legs

To ensure the full crane capacity, all the stabiliser extensions and legs must be fully extended and set to the ground.



WARNING

Take care not to lower the stabiliser leg to your foot.



9.4.1. Stabiliser system and ground conditions

Always:

- Make sure that the ground can support the load that the stabiliser leg imposes on the ground. (*)
- Make sure that the ground is not undermined.
- Use the extra support plates that are large and firm enough for your crane model.

The maximum permitted ground inclination under the stabiliser leg plate is 5°.

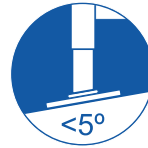
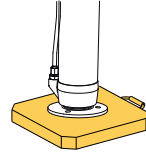

(*) The maximum load that the stabiliser leg can impose on the ground:

Jonsered	P (kN)		
1100R, 1300R, 1088S, 1188S, 1420S, 1250Z, 1400Z, 1500Z	165		
	Separate stabiliser beam		
	B5500	ET450	SY550
	P (kN)	P (kN)	P (kN)
1620Z	165	220	355
2490S, 2850S, 2640Z		220	355



NOTE

Sign that shows the maximum force that the stabiliser legs can apply to the ground.





DANGER

Check that the extra support plates do not bend or sink into the ground.

Do not lower the stabiliser legs on the edge of an embankment, soft ground, hollows, etc... Lower the stabiliser legs only on to a flat, firm and stable surface.

Crane with tiltable stabiliser legs

1. If the stabiliser extensions are equipped with a separate lock, unlock it with the handle (2).
2. Make sure the stabiliser extensions are extended a little, so the stabiliser leg can be rotated freely of the vehicle.
3. Unlock the stabiliser leg lock (1).
4. To tilt the stabiliser leg use lever or button for stabiliser leg. Make sure that you have full control of the movement to avoid risk of crushing.
5. Lock the stabiliser leg lock (1).
6. Extend the stabiliser extension until the yellow mark is visible. If the stabiliser extensions are equipped with a separate lock, lock it with the handle (2).
7. Operate the stabiliser leg downwards until it is set to the ground.

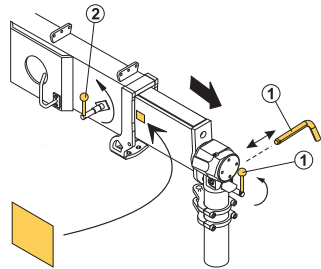

Crane with non-tiltable stabiliser legs:

1. If the stabiliser extensions are equipped with a separate lock, unlock it with the handle (2).
2. Extend the stabiliser extension until the yellow mark is visible. If the stabiliser extensions are equipped with a separate lock, lock it with the handle (2).
3. Operate the stabiliser leg downwards until it is set to the ground.

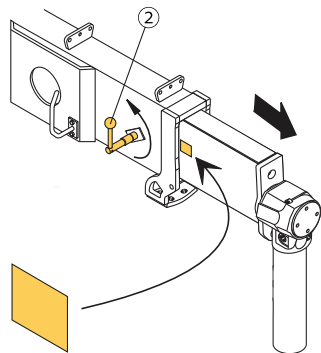

10. During operation

10.1. Operate the crane

Lifting should be carried out in the following order:

1. Lift the load.
2. Move load closer to the crane.
3. Slew
4. Lower the load.

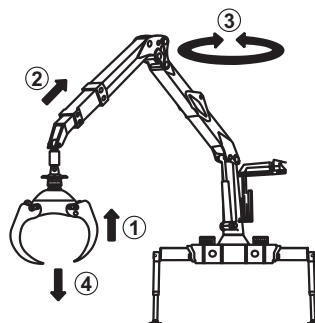

WARNING

- Never go underneath a hanging load or move a load over people.
- The crane may not be used for lifting personnel

Comply with the values listed on the load plate; do not overload the crane. Follow the operation of the load warning indicator. The warning lights will flash when the load exceeds 90 % of the maximum allowed value.

If possible, lift the load from its center of gravity. Do not lift a log from its top end.

Do not lift a load over yourself or the cab

- Never drive the cylinders to their extreme positions at full speed.
- Never operate the stabiliser system while the crane is loaded.
- Ensure that the weight of the load and the vehicle does not rest solely on the stabiliser system. Adjust the stabiliser leg if necessary.
- Do not load from in front of the vehicle: there is a risk of the vehicle tilting over!

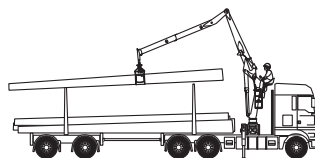



DANGER

Be especially careful when working near electricity lines. Also beware of overhead lines for electrified rail roads. Maintain a distance of at least five meters.

If an accident occurs

- do not touch metallic parts of the crane (the stabiliser legs will ground the crane, and you will be connected to an electric circuit).
- warn others, ask them to move farther away, forbid them from touching the load, crane, vehicle or ground near the crane
- request that power is turned off from the electricity line.

10.2. Slope control [option]

A slope indicator is placed on the crane base to monitor the tilting of the crane . When the tilt of the crane exceeds the angle permitted, a dump valve is activated and the crane switched to idling. All load increasing actions will be stoped until the situation is over. During this period it is possible to operate an appropriate crane function to correct the situation. See picture. Press the stop button while moving the lever.

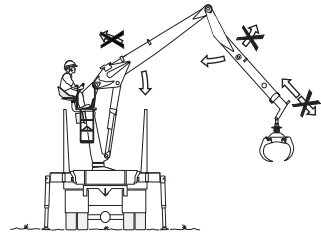

10.3. Adjust the speed of each function for TimberTronic control system

At start up, the system by default is set to full speed. To reduce the speed of each function, use an Allen key and a screwdriver to adjust the screws.

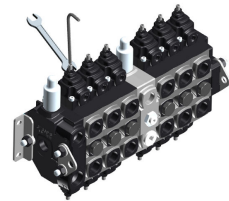

11. Ending crane operation

11.1. Placing the stabiliser system in transport position



DANGER

Do not stand in the stabiliser legs, tilting area.



WARNING

Do not put your foot under the stabiliser leg

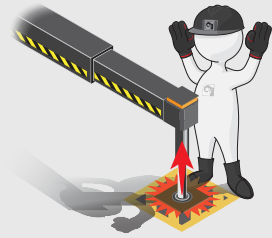

DANGER

Always ensure that the stabiliser legs and the stabiliser extensions are in transport position and securely locked.

Crane with tiltable stabiliser legs

1. Raise the stabiliser leg carefully slightly from the ground.
2. Unlock the stabiliser leg lock (1). Make sure that it remains in the released position.

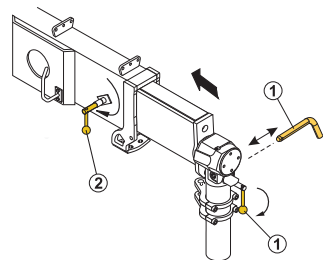

WARNING

Do not stand behind the stabiliser leg. Do not touch the stabiliser leg either.

3. Raise the stabiliser leg slowly until the plate touches the bar on the "inside" of the stabiliser leg.
4. Continue raising the stabiliser leg carefully. It will now move backwards and perform a rotary movement.

5. Stop the operation as soon as the stabiliser leg is almost vertical, lock the stabiliser leg lock (1).
6. If manual operated stabiliser extension: unlock the stabiliser extension with the handle (2) and retract the stabiliser extension completely.
7. If manual operated stabiliser extension: lock the stabiliser extension with the handle (2).

Crane with non-tiltable legs

1. Raise the stabiliser leg.
2. Retract the stabiliser extension completely. (If manual operated stabiliser extension: unlock the handle (2). Retract the stabiliser extension and lock with the handle (2).

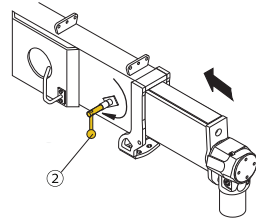

11.2. Electric tiltable seat [option]

To operate the seat up or down.

Push and hold button (1) and operate the switch (2) at the same time.

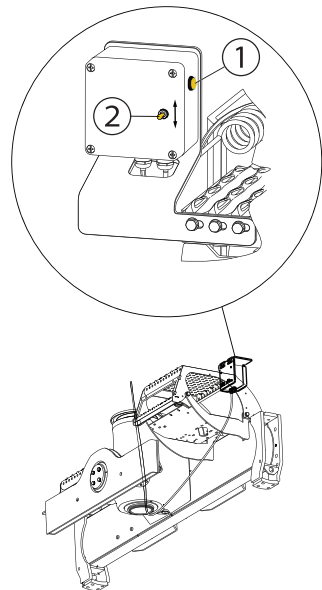

WARNING

Do not stand in front of moving parts. They can cause injuries.

11.3. Ending use



WARNING

- When you finish loading, always stop the hydraulic pump
- Disengage the PTO of the pump and its gear.

- Moving the vehicle is strictly forbidden when the crane is loaded or the boom assembly turned to the side.
- During transportation, the crane must always be in its proper transport position, and the boom system must also be supported in lateral direction.

Support against bunks.

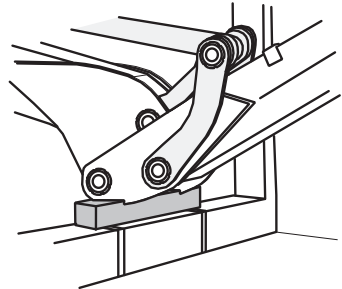
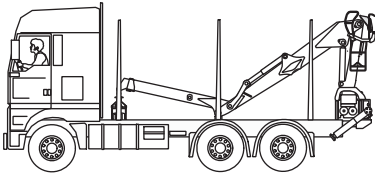

Support against separate support.

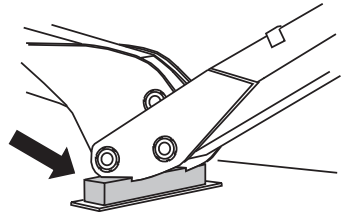
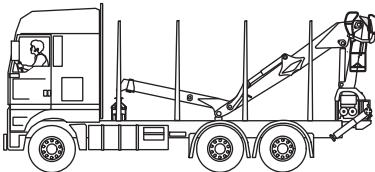

Support the grapple against the bunks or use separate support.

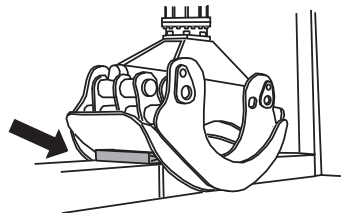
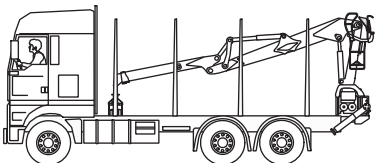



IMPORTANT

- Lock the boom assembly for transport so that the crane will not move by itself
- Operate the boom system into a parking position that prevents free swinging of the grapple during transportation.
- Operate the boom system into a parking position that prevents the grapple from hitting the operator's control station in case of accidental operation of the crane.



WARNING

Do not park the grapple horizontally (an example of incorrect position is shown in the picture).

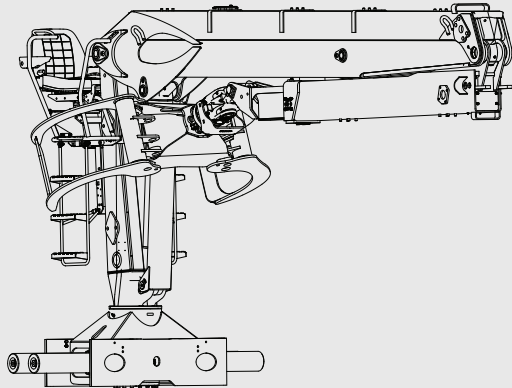

- The stabiliser legs and stabiliser extensions must be retracted and locked during transport.
- Take the total height of the crane and the load into consideration!
- When moving the vehicle, ensure that there is nobody at the crane's control position.
- When the crane is installed on a detachable console at the rear of the vehicle, be especially cautious when uncoupling or recoupling the crane. At such times, nobody is allowed to be near the crane's control position.
- Ensure that the load is properly tied.

11.3.1. For cabins [Option]

- Always lower the cabin to the end position
- Close all doors and windows
- Pull down the protective curtain on the cabin front door
- When moving the vehicle, ensure that there is nobody at the crane's control position.
- When the crane is installed on a detachable console at the rear of the vehicle, be especially cautious when uncoupling or recoupling the crane. At such times, nobody is allowed to be near the crane's control position.
- Ensure that the load is properly tied.

11.4. Warning interface (TWI)



WARNING

If you switch off the safety system when manual operated stabiliser extensions/tiltable legs are not locked in the transport position, and/or if the first boom angle exceeds a certain specified angle, the system will give you a warning.

The vehicle must not be moved.



- A warning, visible and audible from the driving position for transport, indicates when the crane height exceeds a predetermined maximum and when the manual operated stabiliser extensions/tiltable legs are not locked in the transport position.
- The audible warning can be silenced by an acknowledgement button [option] or by a signal indicating that the parking brake of the vehicle is engaged.

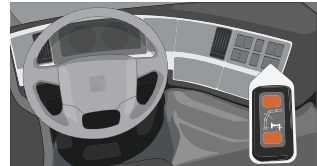

The vehicle must not be moved

1. Switch the system on, put the crane into the transport position.
2. Switch off the system. The vehicle may be moved.



DANGER

After use always put the crane into the transport position! When you have to park the boom on the load space, or over the load, secure the boom and the lifting accessories to prevent any unintentional movement of the crane and the lifting accessories.

11.5. Remove the crane from the vehicle (console mounted)



WARNING

Ensure that there are no unauthorized persons in the immediate vicinity of the crane. When attach/removeing the crane to the vehicle people can suffer fatal crushing injuries!

1. Make sure that the ground where the crane will be parked is firm.
2. Park the crane on the ground, use ground plates if necessary.
3. Fully extend and set the stabilisers to the ground.
4. Rise the crane from the transport support.
5. Disconnect the hoses from the hose hook.

6. Disconnect the chain.
7. Extend the console.
8. Set the stabiliser legs to the ground. Make sure the console is in the center of its sheath.
9. Slew the crane 90 degrees, bend the boom system and support the grapple against the ground.
10. Close the 2nd boom's ball valve.
11. Disconnect the hoses in the following order:
 - Pressure hose
 - Return hose
 - Rest of the hoses (LS line) and the electric cables



NOTE

Pressure in the hoses can prevent the quick couplings from connecting: You can release the pressure:

- by pressing open the quick-acting couplings stem
- from the pressure gauge adapter, using a suitable connector.

11.6. Emergency operation of the dump valve

In event of a failure in the CE system the oil is dumped immediately to the tank. To be able to operate the crane to parked position when it is unserviceable follow these steps.

1. Unscrew the domed nut and break the security sealing on the dump valve
2. Use a screwdriver to turn the screw into a position preventing the normal operation of the crane. Pressurized oil will now enter the system.
3. Operate the crane into parked position

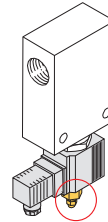

WARNING

Operate the crane with the utmost care. This emergency operation is only allowed to operate the crane to parked/transport position. All other actions is strictly forbidden! The crane may only be taken back in use once the damage has been repaired by an Loglift Jonsered authorized service workshop.

12. Maintenance and Service

12.1. Warranty

Hiab only provides a warranty if:

- The "Warranty – Terms and Conditions" specified in the "Service & Warranty Manual" are fulfilled.
- The crane is inspected and maintained, at least once a year, by a Hiab service workshop as specified in the "Service & Warranty Manual".
- Hiab parts are used for every repair or maintenance work.
- All security seal wires on the valves are still intact.

Always use original Hiab parts and tools.

12.2. Service



DANGER

- Do not do any welding work on the crane yourself! Welding work on the crane may only be carried out by, or in close consultation with, a HIAB service workshop.
- Do not drill into the crane yourself. Drilling work on the crane may only be carried out by, or in close consultation with, a HIAB service workshop.
- Never try to reinstall the crane. Only a HIAB Dealer may reinstall the crane.



Before carrying out any welding on the vehicle

1. Disconnect all electric power to the crane.
2. Contact the manufacture of the vehicle.

Leakage



DANGER

- Keep well away from an oil leak on the hydraulic system! The oil spraying out can cause serious injury. The oil in the hydraulic system is under high pressure.
- Do not replace any hydraulic hoses or lines yourself: Precautions shall be taken when disconnecting hydraulic lines and hoses to ensure that no hydraulic pressure is retained in the line when the power supply to the system is switched off. Pressure may be retained in the hydraulic lines when the power supply has been switched off.
- Always contact a HIAB service workshop.

Deal with an oil leak as follows:

1. Rest the crane on the floor or on the truck platform.
2. Switch off the operating system.
3. Disengage the PTO.
4. Leaking coupling:
 - Tighten the coupling with a spanner.
 - If tightening does not help: contact a HIAB service workshop.
5. Small leak on a a line or hose:
 - Determine if you can still park the crane.
 - If you can: park the crane and go to a HIAB service workshop. If you cannot: contact a HIAB service workshop.
6. In all other cases, contact a HIAB service workshop.

12.3. Follow the maintenance instructions!

Take the crane, at least once a year, to a HIAB service workshop for inspection and maintenance. Maintain lifting accessories according to the supplier's instructions.



WARNING

- Ensure that faults in the crane are corrected immediately!
- Never correct faults yourself that may only be corrected by a HIAB service workshop.
- Carry out yourself only the service and maintenance work you have the requisite knowledge and experience of.

If the crane is not be used for 1 month or longer:

- Lubricate the crane thoroughly according to the instructions.
- Park the crane in the transport position.

Filters

Replace the filter cartridge

- after the first 50 hours operation
- then after every 500 hours operation

- or at least twice a year.

Cleaning

Clean your crane and accessories regularly, but:

- Do not use aggressive cleaning agents.
- Use only cleaning agents with pH between 5-9.
- Use Max water temperature: + 50 C
- Use Max pressure: 140 bar
- Minimum distance between nozzle and the surface: 40 cm
- Never use a high pressure jet cleaner on electronic parts, plastic components, signs, bearings, control valves, cylinders or the oil tank. Only the cranes surface may be cleaned with a high-pressure jet cleaner.

12.3.1. Daily inspection

Stop buttons and stop functions

- Use the crane and its safety system to make sure that the stop buttons, motor stop, dump valve, tilt sensor, TWI and CWI are undamaged and working properly.

OLP [option]

- Operate the OLP function and verify that is working correctly.

Control levers, joysticks, pedals and control rods

- Check that they are undamaged and working properly.

Hydraulic system

- Check that there are no leaks from the hydraulic hoses, cylinders, valves, bottom of the base, joint of the column, lines and connections of the base.

Oil tank level

- To check the level in the oil tank:
Put the vehicle on level ground with the crane in transport position.
- If necessary, top up.

Base oil level

- Check the oil level in the base.
- If necessary, top up.

Add-on equipment

- Check the cables, cable connections, the cable guides and the attachment points for the add-on equipment.
- Maintain all add-on equipment, auxiliary equipment etc. according to the instructions supplied with it.

12.3.2. Additional daily inspection for the cabin (if installed)

Cabin structure

- Check for damage to the cabin structure (e.g. any formation of cracks).



DANGER

In the event of damage that presents a safety risk:

- Do not use the crane.
- Have the damage repaired immediately by a HIAB service workshop.



NOTE

If the glass on the cabins front door is damaged, you need to replace the whole door.

Cabin emergency landing valve

- Check that the cabins emergency landing valve is undamaged and works properly.

AC (if installed)

- Check the condenser coil, clean if necessary
- Check the coarse filter, clean if necessary.

12.3.3. Weekly inspection and maintenance

Shafts and pins

- Check the lockings of shafts and pins.

Steps, passageways and the seat/cab

- Check the steps, passageways and the seat/cab.
- Check the fastening of the seat.

Hydraulic pump

- Check the fastenings of the hydraulic pump.

Hose connections

- Check that the hoses, lines, connectors, cylinders and valves are tight.

Suction hose

- Tighten the suction hose connectors if necessary.

Hydraulic system

- Bleed air from the hydraulic system. Air must be bled from the hydraulic system, if:
 - the system has been under maintenance or repairs.
 - the crane has not been used for a long time.

- inadvertent movements occur during operation of the crane or the controls are slow or inaccurate.

Bearings and joints

Refer to the lubrication schedule to lubricate the following components:

- Base bearing
- Cylinder bearings
- Control lever joints
- Boom system bearings.

Boom extension and the stabiliser beam

- Use spray vaseline or chain oil to lubricate the surface of the second boom and extension.
- Use spray vaseline to lubricate the surface of the stabiliser beam.

Levers

- Lubricate the levers with a grease gun. Note the positions of the levers before greasing.

Chain in extension

- Lubricate with a grease gun.

12.3.4. Additional weekly inspection and maintenance for the cabin (if installed)

Windshield washer for the cabin

- Check the wash fluid. If necessary, top up.

Heather (if installed)

- Check the level in the fuel tank. If necessary, top up.

Lubricate

- Lubricate the cabin door.

Lifting device

- Check lifting device. Make sure it can be driven up and down smoothly and safely.
- Clean the cleaning rods.



NOTE

Do not grease them, use teflon based lubricants.

12.3.5. Monthly inspection and maintenance

In addition to the daily and weekly inspection, carry out the following each month.

Crane structure

- Clean the crane structure and check for damage (for example, any formation of cracks).

In the event of damage that presents a safety risk:

- Do not use the crane.
- Have the damage repaired immediately by a Loglift/Jonsered service workshop.

Presence of load plates and notices

- Check that the symbols near the levers for the main control valve and stabiliser control valve are in position.
- Refer to the chapter "Signs on the crane" and check that all other notices and stickers are in position: load plates, warning symbols.

Boom bearing and cylinders

- Check the fastening.

Bolts and screw fixings on crane, cabin, cabin lifting device and the grapple

- Examine the condition of the bolts and make sure that bolt and screw fixings are tightened. Tighten them if necessary.

Lateral clearance of the boom and/or hydraulic extension

- Adjust the lateral clearance of the boom and/or hydraulic extension.

Chain in extensions

- Check the condition and adjust the telescope chain if necessary.

Grapple

- Lubricate the grapple with a grease gun according to the operator's manual for your grapple.

12.3.6. Additional monthly inspection and maintenance for the cabin (if installed)

In addition to the daily and weekly inspection, carry out the following each month.

AC - Air Condition (if installed)

- Replace the fine filter located inside the AC.

Cabin with MultiDrive control system [option]

- Lubricate the ball joints and the ball joints in the spool end.

Slide pads on the cabin

- Adjust the slide pads in the cabin.

Top locks on the cabin

- Inspect the conditions and make sure that bolt and screw fixings are tightened. Tighten if necessary.

12.3.7. Twice a year maintenance

Take the crane, at least twice per year, to a Hiab service workshop for inspection and maintenance. Carry out the following maintenance:

Oil tank

- Remove condensed water from the oil tank.

Crane base

- Check the oil in the crane base and drain it for condensed water via the drain plug

Spring cups

- Clean spring cups and grease them.

12.3.8. Annual maintenance

Take the crane, at least twice a year, to a Hiab service workshop for inspection and maintenance.

Carry out the following maintenance at least once a year.

Hydraulic system

- Change the oil tank filler cap.
- Change the hydraulic oil.
- Change the oil in the slewing system.
- Replace filters.



NOTE

If the crane is being used in hot climates the oil might need to be changed more often.

Extension

- Check and adjust the vertical clearance of the extensions.

You can adjust the clearance of the extensions (1 or 2 depending on crane type) by adding shims underneath the slide pads.

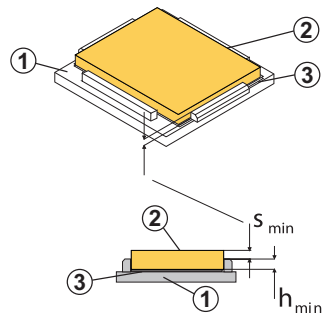

Crane base

- Change the oil in the crane base.

12.3.9. Additional annual maintenance for the cabin (if installed)

Filter

- Replace the cabins air filter.

Spring washers on the chain

- Replace if necessary

12.4. Lubrication



WARNING

Follow the lubrication Instruction exactly. If you not do so, there may be serious damage to the crane and to add-on equipment.

Type of grease

Use lithium based grease containing EP additives (consistencies 2 and 3 are recommended, depending on the climate).

Recommended greases:

BP LS EP 2, ESSO UNIWAY EP2 N, AGIP GR MU/EP3, NYNÄS UNIFETT EP.



NOTE

Avoid grease with graphite or molybdenum-disulphide additives.

12.4.1. Lubrication

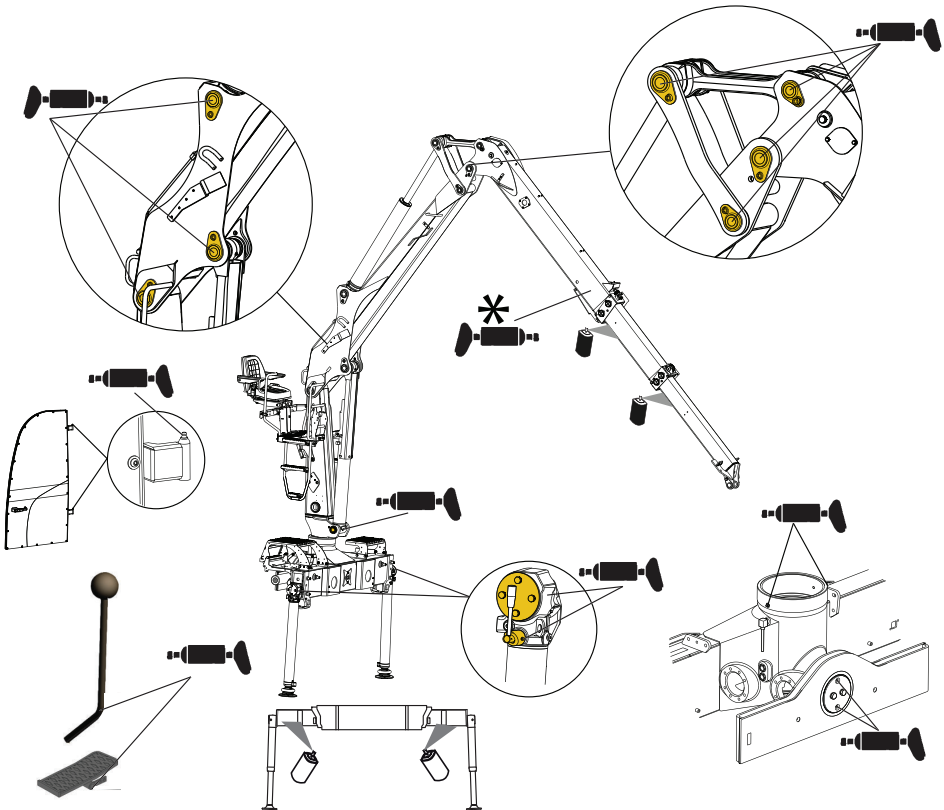

*Only for telescopic booms with 2 extensions.

The location and the number of greasing points can vary from the illustrations.

12.4.2. Lubrication of the upper column bearing



DANGER

The upper column bearing must be lubricated while the crane is slewed. If one person lubricates the upper column bearing, while another is slewing the crane: Take care that the person lubricating the bearing does not come into contact or get crushed by the crane!

If you are lubricating the upper column bearing without help:

- Lubricate the upper bearing with a little grease.
- Slew the crane a little.
- Again lubricate with a little grease. Repeat, until the column has been slewed round completely.

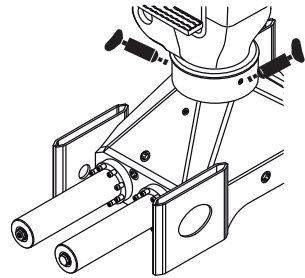

12.4.3. Lubrication of ball joints in cabin

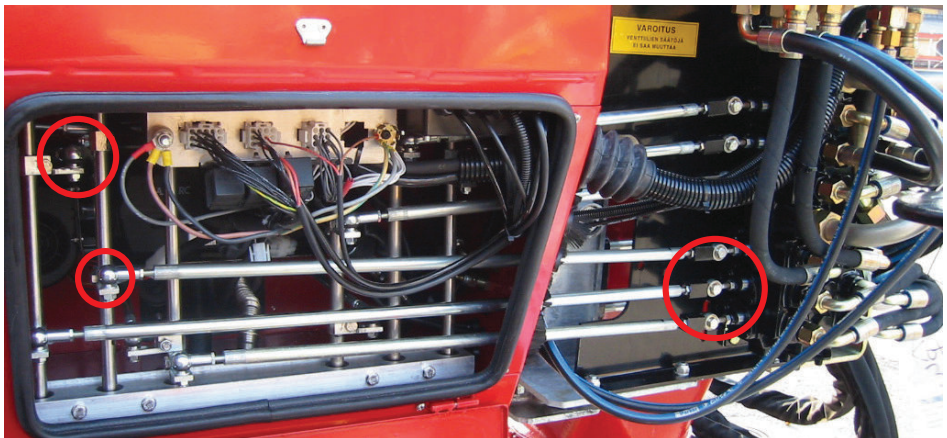

All ball joints must be lubricated monthly. Do not forget the ball joints on the spool ends. The image shows examples of the location of the ball joints.

12.4.4. Clean and grease the spring cups.

1. Open the spool spring cups,
2. Clean the springs
3. Fill with grease.

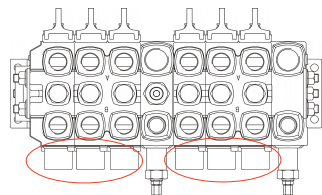

12.5. Adjust the lateral clearance of the boom and/or hydraulic extension

Turn the bearing covers an equal amount on both sides.

Turn the covers all the way closed. Then open them one quarter of a turn.

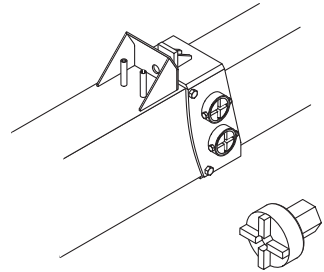

12.6. Adjust the chain in the telescope

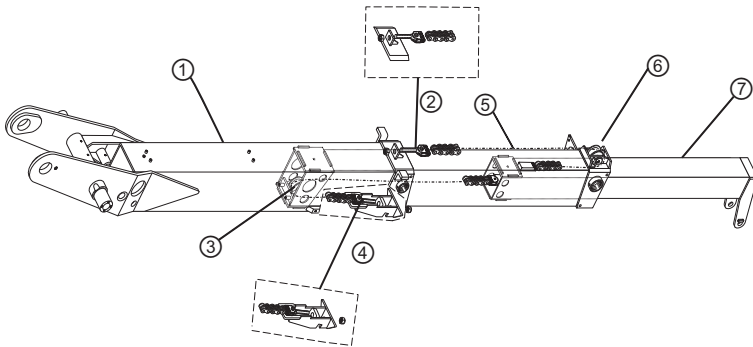

- (1) second boom
- (2) chain tensioner
- (3) roller
- (4) chain tensioner
- (5) extension 1
- (6) roller
- (7) extension 2

The correct tightness prevents the chains from overloading and wearing out too quickly. Correct adjusted chains will also not jump off the groove in the roller.

1. Retract the extensions. Lower the grapple to the ground.
2. Loosen the adjustment screw of the top chain fastener until the chain is visibly loose.
3. Tighten the adjustment screw of the bottom chain. Extension 2 will retract until the extensions come in contact with each other. Check that the top chain is still loose. Loosen the adjustment screw of the bottom fastener until a small gap is created between the nut and the second boom and extra chain tension is removed.
4. Raise the 2nd boom until it is level and keep the grapple near the ground. Extend the extensions. Slightly retract the extensions (2 to 5 cm) to loosen the top chain. Leave the 2nd boom in the air to avoid the top chain from tighten.

5. Tighten the top chain with the adjustment screw. The correct tension is achieved when it is possible to move the chain vertically about 1.5 to 3 cm from its center by hand.
6. Check the chain adjustments by extending and retracting the extensions a couple of times.

12.7. Cabin [option]

12.7.1. Adjust the slide pads in the cabin

Tighten the screws against the sliding pads, first upper (1) and then lower (2) set screw.

Tightening method: Tighten 1/4 round. Tighten 1/4 round a second time. Repeat on the other side.

If needed, hit with a rubber mallet against the locking plate to ensure the right position of each sliding pad.

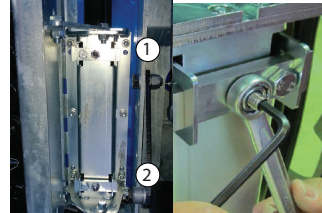

12.7.2. Tightening of screws and bolts in cabin

Tighten the fastening nuts shown in images A and B.

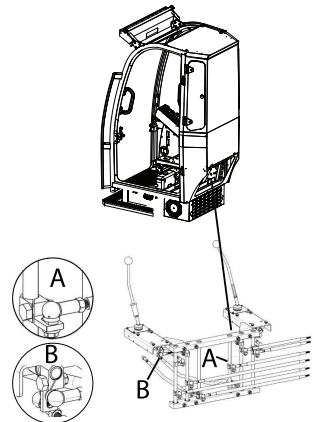

12.7.3. Windshield wiper fluid

1. Open the side door.
2. Pull out the container.
3. If necessary, top up.

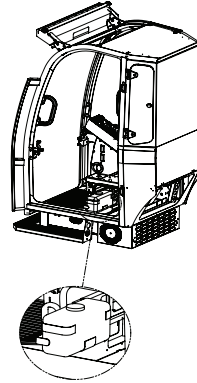

12.7.4. Change wiper blade

1. Unscrew the screw and remove the wiper blade (1).
2. Place the old wiper in a recycling bin (2).
3. Fasten the new wiper with the screw (3).

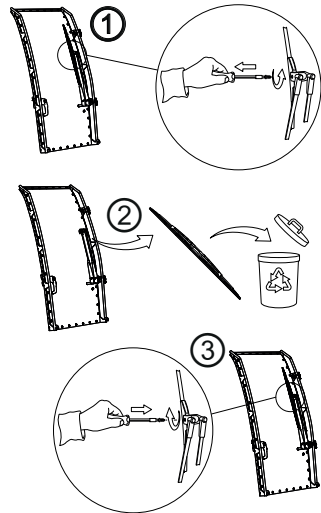

12.7.5. Replace leds on the control panel

1. Remove the button from the control panel (1)
2. Remove the old led (2)
3. Replace with a new led
4. Reattach the button on the control panel (1)

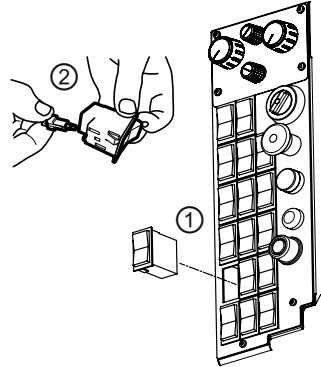

12.7.6. Change the air filter

1. Open the service hatch on the cabin (1).
2. Remove the air filter (2).
3. Replace with a new filter.

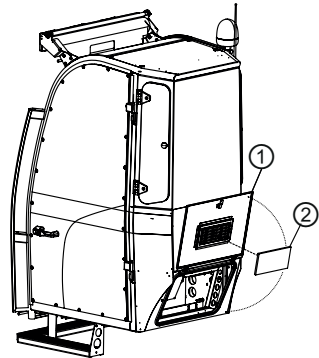

12.8. Hydraulics

12.8.1. Crane base: checking the oil level/oil change

Checking the oil level in the crane base

1. The oil level must reach the bottom edge of the top oil level eye. the crane slewing system and the lower bearing of the column must be fully submerged in oil bath.
2. If the oil level is below the minimum level, top up through the filling hole with transmission oil of type MIL-L-2105C or API-GL-5, viscosity SAE-80W-90

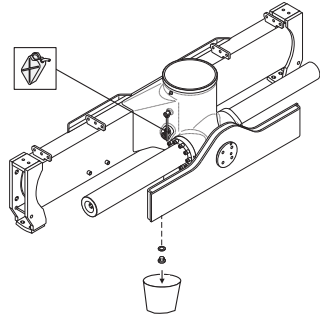

Changing oil in the slewing housing

Change the oil in the slewing house yearly!

1. Use a container with sufficient capacity to receive the oil. Drain off the oil through the drain plug.
2. Refill through the hole for the measuring stick, with transmission oil of type MIL-L-2105C or API-GL-5, viscosity SAE-80W-90.
3. Slew the crane, after filling to the end positions, three times.
4. Check the oil level. If necessary top up again.

12.8.2. Bleeding air from the hydraulic system

Bleed the air from the hydraulic system:

- after changing the hydraulic oil
- after working on the hydraulic system
- if your crane works slowly or jerkily



WARNING

Air in the hydraulic system can lead to faults and damage

To bleed air from the hydraulic system, proceed as follows:

Move each crane cylinder and each hydraulically operated piece of add-on equipment at least twice to its end positions (slowly).

12.8.3. Replacing the cartridge in return oil filter

Return oil filter with clogging indicator



NOTE

Do not clean the filter.

Replace the breathing filter of the filler cap at the same time as the return filter cartridge.

When clogging indicator turns red or filter time is reached (whichever is the sooner), the cartridge must be replaced. **If indicator is not fitted, replace the cartridge periodically as recommended by Hiab.**



WARNING

Dirt will damage the hydraulic system

Make sure that the area around the filter is clean to prevent contamination of the hydraulic oil.

1. Switch off the hydraulic system and release the filter of pressure.
2. Clean the immediate surrounding area of the filter.
3. Remove the cover.
4. Remove the filter cartridge with attached filter housing by using the handle.
5. Examine the surface of the filter cartridge for dirt residue and larger particles; these can indicate damage to the components.
6. Examine the filter housing for any possible mechanical damage.
7. Replace the filter cartridge with a new one.
8. Remove old O-rings and replace (oil before assembling).
9. Place the filter cartridge carefully into the filter housing and screw. Pay attention to the position of the handle.
10. Install the filter cartridge with attached filter housing.
11. Refit the cover.
12. Replace the breathing filter in the filler cap.
13. Switch on hydraulic system and check the filter for leakage.

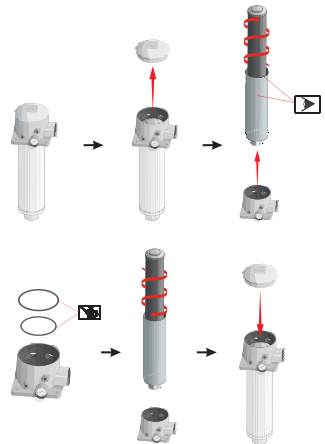

12.8.4. Replacing the cartridge in high pressure filter

- (1) High pressure filter
- (2) Optical indicator
- (3) Cartridge

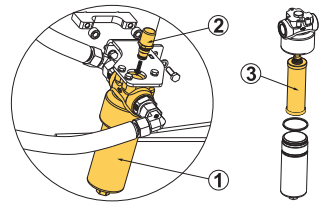

WARNING

Dirt will damage the hydraulic system



NOTE

DO NOT clean the filter cartridge.

When clogging indicator turns red or filter time is reached (which ever is the sooner), the cartridge must be replaced. **If indicator is not fitted, replace the cartridge periodically as recommended by Hiab.**

1. Switch off hydraulic system. Release filter of pressure.
2. Clean the immediate surrounding area of the filter.
3. Remove the oil drain plug. Collect oil in a suitable container.
4. Unscrew the filter housing. Collect oil in a suitable container and clean or dispose of it in accordance with environmental regulations.
5. Remove the filter cartridge. Examine the surface of the cartridge for dirt residue and larger particles; these can indicate damage to the components.
6. Clean the filter housing.
7. Examine the filter housing and head segment, especially sealing surfaces and thread, for mechanical damage.
8. Always replace the O-ring of the filter housing.
9. Oil the threads and sealing surfaces on the filter housing and head segment, as well as the O-ring.
10. Replace the filter cartridge with the new one and screw carefully.
11. Fully tighten the filter housing. Then, unscrew it 1/4-turn back.
12. Screw the oil drain plug.
13. Switch on hydraulic system and check the filter for leakage.

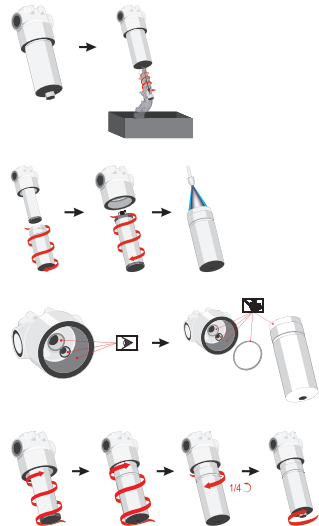

12.8.5. Checking the oil tank level

1. Place the crane and stabiliser legs in the transport position.
2. Place the vehicle on level ground.
3. Check the oil level in the tank.
4. Oil level too low:
Top up with hydraulic oil.



12.8.6. Changing the hydraulic oil



WARNING

The oil can be hot and cause injury.

1. Operate the crane for a while to warm the oil. Place the crane in the parked position. Take care that the temperature of the oil does not exceed the point where you can handle it safely. If this occurs allow the oil to cool before moving to the next step.



WARNING

- Suitable eye and hand protection must be worn while carrying out this operation, and if there is a risk for inhalation of oil mist, a mask as well.
- Inhalation of oil mist: Contact a doctor.
- Skin contact: Remove polluted clothing, wash with soap and water. In the event of high pressure injection of the product, see a doctor without delay.
- Eye contact: Rinse eyes with plenty of water, see a doctor if irritation persists.

2. Drain the oil tank through the drain plug. Make sure the system contains as little as possible. Use a container with sufficient capacity.
3. Change at the same time:
 - all filters
4. Refit the drain plug.

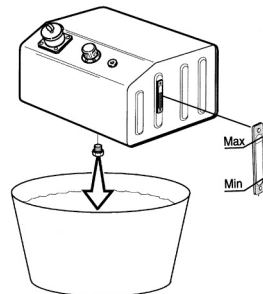

NOTE

Ensure the waste oil is disposed of safely and in accordance with local environmental regulations.

Filling the oil tank with hydraulic oil

The oil used for filling must be clean. Do not mix different oils.

Hydraulic oils must have been dealt with according to cleanliness requirements ISO 4406: -/16/13.

Hydraulic oil that is approved for Hiab products must comply with one of the following standards or equivalents:

- ISO 11158 HV
- DIN 51524 part 3 HVLP
- ISO 6743/4 L-HV

Suppliers of hydraulic oil must verify that the quality and performance of the oil complies with the above standards.

When changing from mineral oil to a non-polluting synthetic oil, or when changing to biodegradable oil, contact a Hiab service workshop.

Viscosity of oil

The viscosity of the oil is of great importance to achieve high efficiency of the hydraulic system.

The naming of the oil in the table below: 32, 46 or 68 tells the viscosity of that oil at 40°C (reference temperature).

Viscosity of oil at 40°C	Temperature range
32	-25°C to 75°C
46	-15°C to 90°C
68	-5°C to 90°C

The recommended viscosity during normal working conditions is between 16 and 40cSt.

Hiab strongly recommend an oil working temperature below 70°C. If necessary consider an oil cooler or heater.



NOTE

When working in arctic condition consider an oil with lower viscosity than the 32 oil in the table above.

Environmentally Friendly Oil

The environmentally friendly oils recommended for Hiab products are ester based synthetic hydraulic fluids (synthetic ester).



NOTE

Vegetable oils do not meet Hiab's requirements and must not be used.

After filling the tank

1. Operate each crane function to its end positions.

2. Operate the crane to parking position.
3. Check and top up the oil tank to max level on the tank gauge.
4. Bleed the system.

12.9. Troubleshooting

12.9.1. Faults in the crane

Faults in the crane must be rectified immediately.



DANGER

- Only correct yourself the faults that according to the table you may rectify.
- Follow the instructions exactly!
- All other faults may be dealt with only by personnel in a HIAB service workshop!

Fault	Probable cause	Action
The hydraulic pump makes a noise. Three causes: Warning! Stop using the crane immediately!	Oil tank filler cap air filter is blocked.	Clear the blockage or replace the entire filler cap.
	Oil level in the tank is too low.	Top up the oil tank and bleed the hydraulic system.
	The pump is faulty.	Go to a HIAB service workshop.
The stabiliser extensions do not slide out.	The extensions are still locked.	Unlock the extensions.
	Hydraulic fault.	Go to a HIAB service workshop.
The slewing movements are irregular or cause abnormal noises.	Insufficient oil in the hydraulic system.	Top up the oil tank.
	Insufficient oil in the gear box.	Top up the oil in the gear box to the required level.
	Bearing assemblies and pinion are not properly lubricated.	Lubricate the bearing while slewing.
	Bearing assemblies or pinion are damaged.	Go to a HIAB service workshop.
Add-on equipment does not work properly.	Connectors not properly connected.	Reconnect the add-on equipment according to the instructions.
	Other defect.	Go to a HIAB service workshop.

Fault	Probable cause	Action
Leak on hydraulic system: leaking coupling, hose or line. Danger! Keep well away from an oil leak.		1. Press a Stop button. 2. Disengage the PTO. 3. Contact a HIAB service workshop.

12.9.2. Faults on the CE device

Faults in the crane must be rectified immediately.

Every CE device is tested before delivery. If you encounter problems, check the troubleshooting chart below before contacting Hiab service workshop.



DANGER

- Only correct yourself the faults that according to the table you may rectify.
- Follow the instructions exactly!
- All other faults must be corrected by personnel in a HIAB service workshop!

Fault	Action
The crane cannot be operated (oil flows in unloaded circuit). The warning triangle possibly double-blinks.	1. Check that the stop button has been released. 2. Check that there are no other hydraulic/mechanical faults – PTO can be activated, etc. 3. Check that the wire from the dump valve to the electric unit is undamaged 4. Disconnect the Hirschmann connector from the dump valve and measure that there is a voltage of 24 VDC between terminals 1 and 2 5. If the dump valve receives 24 VDC but oil still flows in unloaded circuit, the dump valves must be replaced at Hiab service workshop.
The warning triangle in the CE electric unit double-blinks regardless of the crane's load.	1. Check that the stop button has been released. 2. Check that all the cables are undamaged 3. Go to a Hiab service workshop
The warning triangle does not blink/ stay lit at maximum load.	Go to a Hiab service workshop
The truck's engine stops when the hydraulic PTO is switched on, when the crane's CE system controls the engine stopper.	1. Check that the stop button has been released. 2. Check the connections 3. Go to a Hiab service workshop

Fault	Action
The truck's engine will not stop when the emergency stop button is pressed while the hydraulic PTO is on, when the crane's CE system controls the engine stopper.	<ol style="list-style-type: none">1. Check that the stop button works properly2. Check that all the cables are undamaged3. Check that there are no faults in the truck's connections.

13. Diesel heater [Option]

13.1. Diesel heater [option]

Factory mounted heater has a switch at the control panel inside the cabin. It is possible to install a separate switch inside the vehicle cab.

Start the diesel heater

Turn the switch (1) clockwise to activate the heater. The temperature is adjustable from +10°C to + 40°C, when correct temperature is reached, the output is reduced.

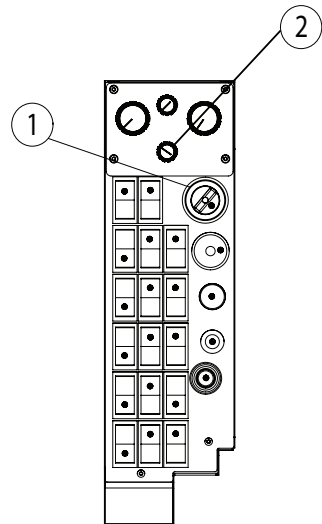

NOTE

It takes about three minutes for the heater to start up. If necessary, the starting process can be repeated.

The switch is stepless. A delay for the adjustment can occur.

Turn the switch (2) to adjust the speed of the fan. The fan is adjustable in four steps, off = 0 , slow=1, medium = 2 and fast =3.

Stop diesel heater:

Turn the switch (1) anticlockwise to turn off the heater.



DANGER

It is not allowed to use the power supply to turn off the heater.

Diesel

(1) Diesel tank on cabin.

Use suitable winter diesel when the temperature is below 0°C. The diesel must not develop any paraffin crystal. If winter diesel is not available add paraffin oil or petrol according to the table below:

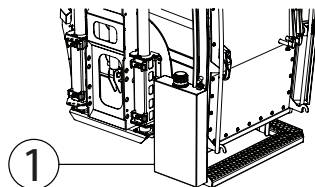

Temperature	Winter diesel	Additive
0°C ... -25°C	100%	-
-25°C ... -40°C	*50%	50% petrol or paraffin oil

* or 100 % special diesel fuel for cold temperature



DANGER

The diesel heater must be off when filling fuel.



NOTE

When changing fuel it takes about 15 minutes for the fuel to fill the system.

During summer, operate the diesel heater at least 15 minutes every four week.

Troubleshooting

If the heater does not start, try to restart it and:

- Check that there is fuel in the tank.
- Check that all fuses in the cabin are OK .
- Check all electrical cables and connections.
- Check that there is nothing that clogging the combustion air supply or exhaust system.

If the problem remains or the heater has other problems, check the table below or contact a Hiab service workshop.

Heater cuts out automatically	
Possible cause	Repair action
No combustion after start and restart	Switch heater off and then on again
Flame extinguishes during operation	Switch heater off and then on again
Heater overheats	Check that the hot air system is clear, allow the heater to cool, switch heat off briefly (min 2 seconds) and then on again

Battery voltage too low	Charge battery Switch heater off and then on again
-------------------------	---

Heater produces black smoke	
Possible cause	Repair action
Combustion air and/or exhaust system blocked	Repair action

14. Technical Data

14.1. Load plate table

The Installer must fill in the valid meters (**m**) and kilos (**kg**) in this table, following instructions given in the Installation instructions manual.

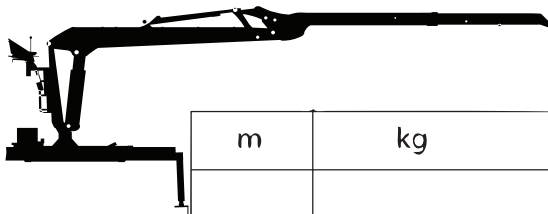

m	kg

The enclosed Technical Data must be stored together with this Operator's manual.

15. Decommissioning

15.1. Decommissioning a crane

Cranes are designed and manufactured taking the environment into consideration. Environmental requirements and soundness have been considered when selecting the raw materials. The metal parts are designed to achieve a light and durable construction, this includes the selection of higher-quality grades of steel. When the crane is decommissioned at the end of its service life, years from now, waste will be created, which must be utilized and disposed of correctly. The crane must be decommissioned properly. Most of the crane's raw materials can be recycled.

Follow the regulations of the local authorities!

- Oil and grease must not be spilled on to the ground or released into the environment!
- Drain the oil from hydraulic cylinders, valves and hoses.

Sort the waste

- Deliver the metal parts for recycling, for reuse as raw material. These are load-bearing, structures manufactured from steel or cast iron, hydraulic cylinders and lines drained of oil, directional control valves, shafts, bearing bushes, control levers, small parts.

Energy waste can be utilized by incinerating it at a proper waste incineration plant

- spiral wraps, manufactured from polyethene, plastic, bearings (cleaned of lubricants) used in the column, beam system etc, manufactured from polyamide plastic.

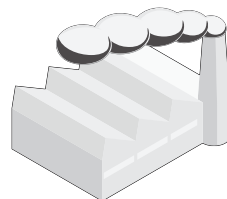
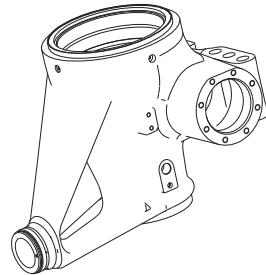
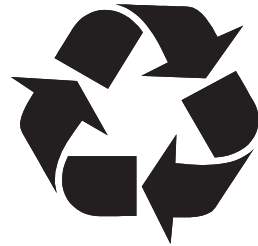

Unsorted waste should be delivered to a landfill

- drained hydraulic hoses, electrical wires, control cables, seat, hydraulic cylinder seals, lights, small plastic and rubber parts.

Hazardous waste is delivered to a collection point for hazardous waste

- oils: hydraulic oil, transmission oil from the slewing system
- solid lubricants: greases from the joints and journal bearings
- other waste containing oils and greases: hydraulic oil filters.

